



[garant.de](http://garant.de)

## G-TEC® – Die Innovations-Oberfläche G-TEC® – The innovative finish

Hinterlässt keinen Abdruck, sondern Eindruck  
Excellent anti-fingerprint properties



# Themen

## Themes

Seite 04–05 DieTÜR – Digitales Türentool | DieTÜR – Digital door tool

Seite 06–07 Die Premiumkante | The premium edge

Seite 08–09 G-TEC® – Die Innovations-Oberfläche | G-TEC® – The innovative finish

Seite 10–43 **NORMTÜREN-PROGRAMM | STANDARD DOOR RANGE**

Seite 12–41 NORMTÜREN | STANDARD DOORS

Seite 42–43 Gesamtübersicht NORMTÜREN | Overview of all STANDARD DOORS

Seite 44–77 **DESIGNTÜREN-PROGRAMM | DESIGN DOOR RANGE**

Seite 42–75 AURA | AURA

Seite 76–77 Gesamtübersicht DESIGNTÜREN | Overview of all DESIGN DOORS

Seite 78–85 Elemente | Elements

Seite 86–117 **TECHNISCHE DETAILS | TECHNICAL DETAILS**

Seite 88–95 Glas-Übersicht | Glass overview

Seite 96–111 Beschläge | Fittings

Seite 112–113 Kantenausführungen, Bänder | Frame types, hinges

Seite 114–117 G-TEC®-Eigenschaften | G-TEC® properties

Seite 118–119 Maße | Dimensions

Seite 120–123 Gesamtübersicht | General overview





# DieTÜR – Digitales Türentool

## Über 1 Millionen Kombinationen für Ihre Wunschtür

### BEQUEM WUNSCHTÜR KONFIGURIEREN

In einer Türenaustellung ist nur für eine bestimmte Anzahl an Modellen Platz. Nicht alle Varianten einer Tür können gezeigt werden. Um diese Lücke zu schließen, haben wir das Online-Tool „DieTÜR“ entwickelt. Hierüber haben Sie und Ihre Kunden Zugriff auf über 1 Millionen Kombinationen einer Tür – und mit jedem Update werden es mehr. Ein Highlight bietet die Funktion „Tür im Raum darstellen“. So kann sich der Kunde seine Wunschtür besser in seinem Haus vorstellen.

Außerdem kann er seine Wunschliste samt QR-Code ausdrucken und damit zu Ihnen in den Fachhandel gehen. Vor Ort scannen Sie einfach den QR-Code und wissen sofort, was der Kunde möchte.

QR-CODE AUF DEN FOLGSEITEN SCANNEN UND EINFACH SELBST KOMBINIEREN

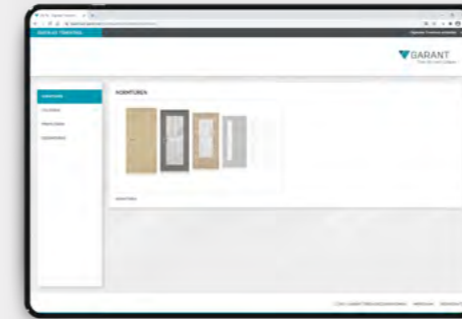
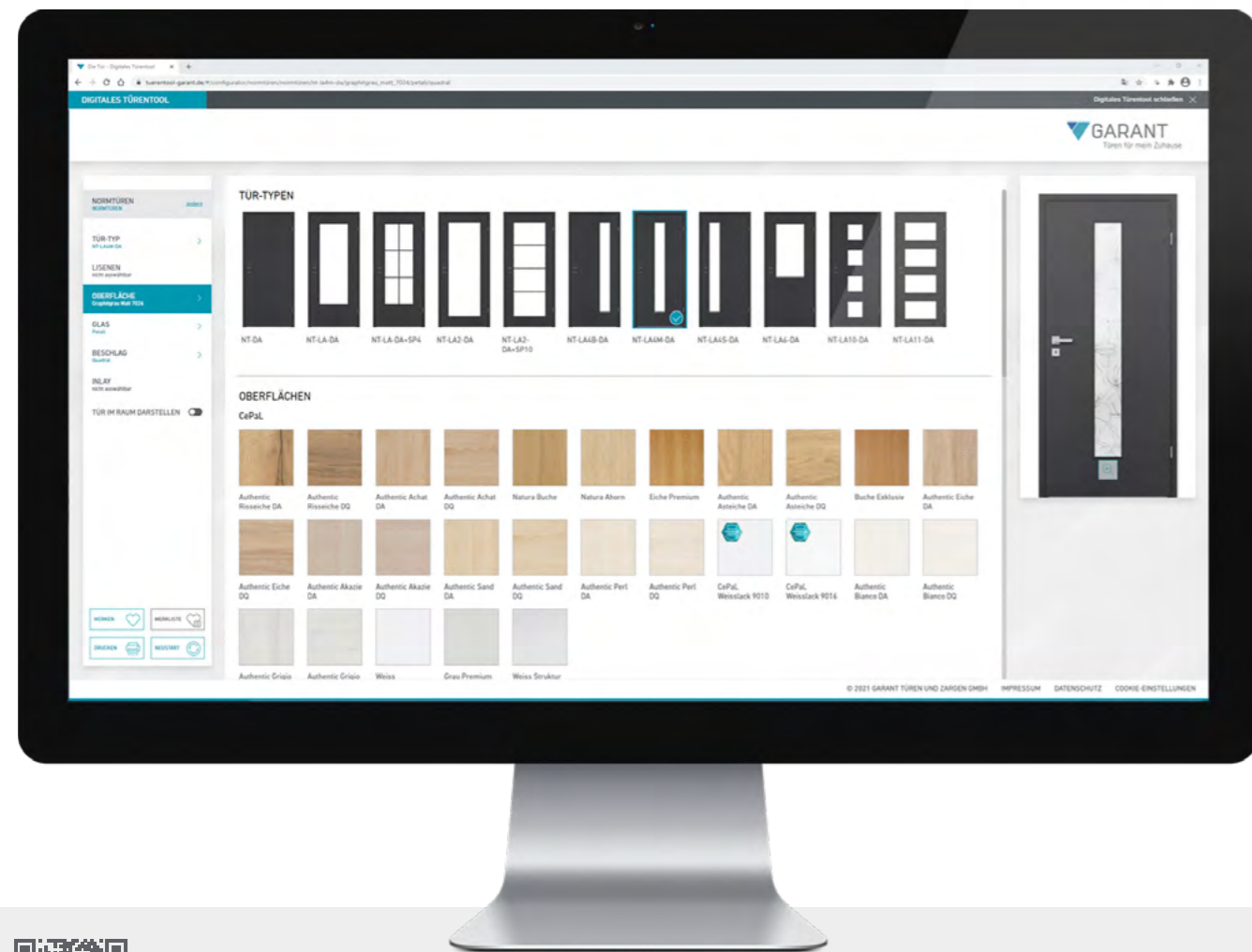

### SCHRITT 1:

#### SO EINFACH FUNKTIONIERT DAS ONLINE-TÜRENTOOL VON GARANT

Im ersten Schritt können Sie oder auch der Kunde daheim zwischen den 4 verschiedenen Türkategorien Norm-, Stil-, Profil- und Designtüren auswählen. Einfach anklicken und Sie landen in der jeweiligen Übersicht. Dort konfigurieren Sie die Wunschtür für Ihren Kunden bis ins kleinste Detail. Ihr Kunde kann auch schon vorarbeiten und trifft eine erste Auswahl vorab zu Hause und Sie beraten detailliert weiter.

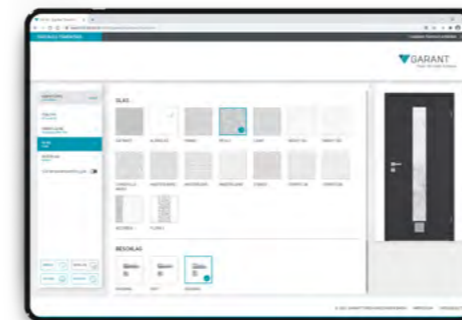

### SCHRITT 2:

#### INDIVIDUALISIERUNG DER TÜR, JETZT AUCH MIT GRIFFWERK-BESCHLÄGEN

Innerhalb der jeweiligen Kategorie können Sie zwischen verschiedenen Türtypen wählen – zum Beispiel mit oder ohne Glas. Oder soll es vielleicht eine Oberfläche in Eiche oder Ahorn sein? Sie haben die Wahl zwischen verschiedensten Oberflächen, Gläsern und Beschlägen. Je nach Türtyp bieten sich unterschiedlich viele Auswahlmöglichkeiten.

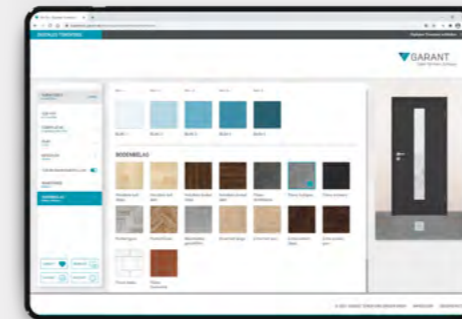

### TÜR IM RAUM

Mit einem Klick sieht der Kunde mit der Funktion „Tür im Raum“ seine konfigurierte Wunschtür im Umfeld von Wand und Boden und kann so überprüfen, ob seine Vorstellungen auch stimmig zur Raumsituation – TÜR, BODEN, WAND – passen. Um die beste Kombination zu finden, können Wandfarbe und Bodenbelag farblich passend zur Tür getestet werden.



### DAS ERGEBNIS:

#### BERATUNG UND BESTELLUNG BEIM FACHHÄNDLER

Wenn der Kunde seine Wunschtür zu Hause konfiguriert hat, kann er sie einfach auf den Merkzettel packen oder gleich ausdrucken und damit für eine tiefere Beratung und anschließende Bestellung zu Ihnen gehen.



# Die Premiumkante – erstklassige Kantentechnologie für zahlreiche Einsatzgebiete



Mitten im Leben –  
**Stoßegal**  
Das Original von GARANT  
mit Nullfugentechnik

Alles zum Thema Premium-  
kante finden sie hier:  
[premiumkante-garant.de](http://premiumkante-garant.de)



KLICK

## Harte Alltagsbelastungen sind unseren Türen mit Premiumkante stoßegal:

Denn die neuartige Funktionsbeschichtung mit Nullfugentechnik sorgt für einzigartige Stoßfestigkeit – und das ist nur einer von vielen Vorteilen:

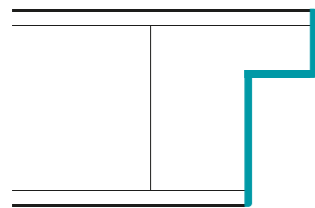

PREMIUMKANTE

Hochwertige Premiumkante  
als 2 mm Dickkante

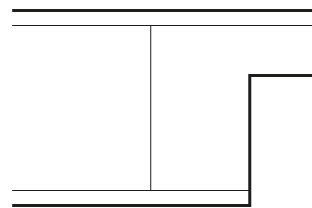

STANDARDKANTE

### DIE VORTEILE DER PREMIUMKANTE AUF EINEN BLICK:

- Reduziertes Verletzungsrisiko durch abgerundete Fräsradien im Kantenbereich („Kita-Kante“)
- Sehr niedrige Schmutzanfälligkeit, Reinigung mit haushaltsüblichen Mitteln
- Reinigungsfreundlichkeit durch versiegelte Kantenoberfläche, meist rückstandslose Entfernung von Verschmutzungen möglich
- Hohe Beständigkeit gegenüber Feuchtigkeit und Chemikalien
- Hohe Beständigkeit gegenüber aggressiven Löse- und Reinigungsmitteln
- Erhöhte Stoßfestigkeit (2 mm Dickkante), Absplintern der Kante nicht möglich
- Hohe Farbeständigkeit der Kante im Vergleich zu anderen Systemen
- Zertifizierte Kantenstoßfestigkeit E (KSF-E)

**RAL**

GÜTEZEICHEN

Innen-  
türen

RAL-GZ 426/1  
Türblatt (KSF-E)



Erhöhte  
Stoßfestigkeit



Hohe  
Reinigungsfreundlichkeit



Erhöhte  
Feuchtebeständigkeit



Verringerte  
Verletzungsgefahr



Verbesserte  
Langlebigkeit



KLICK 

Englische Übersetzung dieser Seite | English translation of this page



# G-TEC® –

## Hinterlässt keinen Abdruck, sondern Eindruck und jetzt auch mit Premiumkante

### DAS G-TEC®-SORTIMENT VON GARANT

Die GARANT-Oberflächen Graphit-, Staub-, Seidengrau und Weißlack weisen eine qualitativ hochwertige G-TEC®-Oberfläche auf, die eine hochmatte Farbgebung gewährleistet. Diese Elemente garantieren eine angenehme Haptik mit praktischen Antifingerprinteigenschaften. Gerade bei der Wahl einer dunklen Farbe ist es entscheidend, dass selbst bei einer intensiven Nutzung keine Fingerabdrücke zu sehen sind. Zudem bleibt dieser Effekt auch nach einer sanften Reinigung erhalten. Lichtecht und weniger kratzempfindlich steht diese Oberfläche für eine lange Nutzungsdauer und eine gewisse Belastbarkeit.

G-TEC®-Türen und -Zargen können wahlweise mit einer kleinen Rundkante oder Premiumkante ausgestattet werden. Verschiedene Türblattausführungen und Innenlagen können umgesetzt werden. Sie lassen sich ideal mit strukturierten Gläsern sowie Ganzglastüren kombinieren. Unterschiedliche Beschläge aus edlem Stahl oder der interessante Drücker QUADRAL-Inlay runden das Erscheinungsbild ab und ergeben ein bemerkenswertes Spiel mit Stil.



Anti-Fingerprint –  
Keine Fingerabdrücke



Hochmatte  
Trend-Oberfläche



Weniger kratzempfindlich  
≥ 1,5 N nach Erichsen



Verbesserte  
Oberflächenruhe



Alle vier Oberflächen  
auch mit PK2.0 lieferbar

WEISSLACK MATT 9016

SEIDENGRAU MATT 7044

STAUBGRAU MATT 7037

GRAPHITGRAU MATT 7024

SCHWARZ MATT 9005



Innovations-Oberfläche  
G-TEC® – ANTI-FINGERPRINT

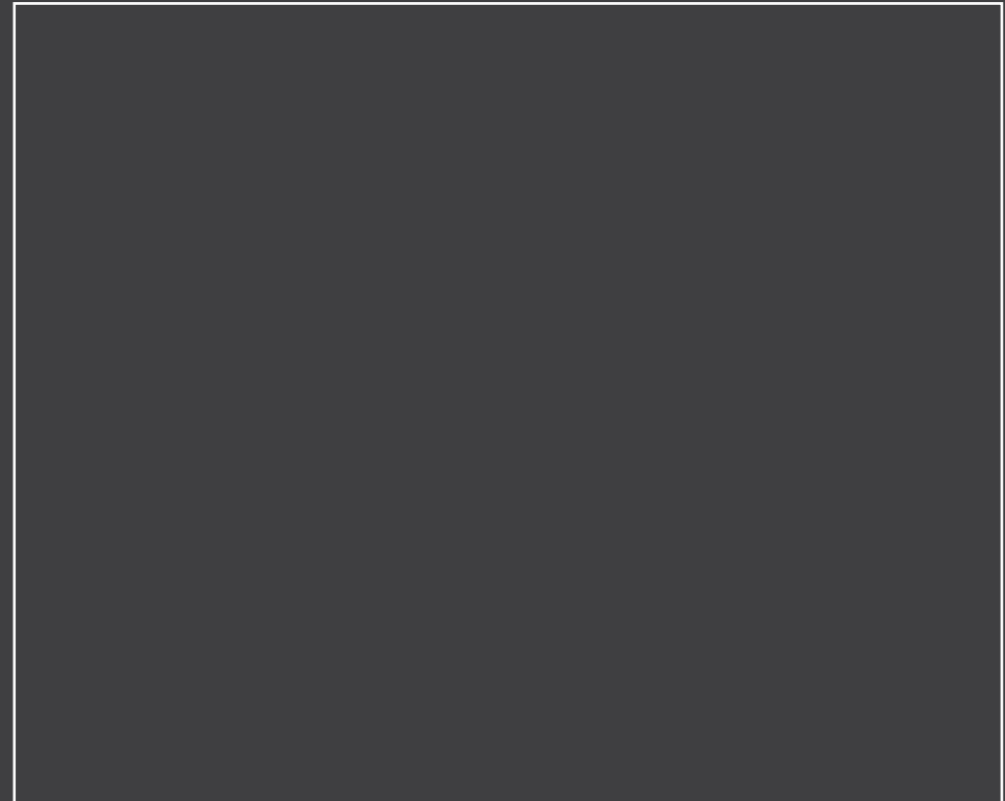

Marktübliche Oberfläche



KLICK 

Englische Übersetzung dieser Seite | English translation of this page

# Das NORMTÜREN-Programm

The STANDARD DOOR range

Das gute und sichere Gefühl, die richtige Wahl getroffen zu haben:  
Unsere NORMTÜREN sorgen jeden Tag für entspannte Wohnlichkeit.

You can be assured of making the right choice because the doors in  
our STANDARD range provide comfort and convenience day after day.



Anti-Fingerprint







**NORMTÜREN**  
**G-TEC® Weißlack Matt 9016**

STANDARD DOORS  
G-TEC® Matte White Varnish 9016

Weißlacktüren sind zeitlos schöne Klassiker für jeden Wohnstil. Mit supermatter Oberfläche setzen sie trendige Akzente in jedem Raum.

Classically beautiful white varnish doors have timeless appeal and harmonise with any style of interior design. With an ultra-matte finish they make a stylish addition to any room.





NORMTÜR  
G-TEC® Weißlack Matt 9016

Wohnliche Eleganz in  
Weiß mit modernem Touch.

Homely elegance in white with  
a modern touch.

Selbstverständlich unempfindlich.  
Naturally robust.

QUERSCHNITT | CROSS

KLEINE RUNDKANTE | SMALL ROUNDED EDGE



Lichtausschnitt-Türen geschlossene Türen



PREMIUMKANTE | PREMIUM EDGE



Lichtausschnitt-Türen geschlossene Türen



BESCHLAG  
QUATTRA INLAY

GRAPHITSCHWARZ  
GRAPHITE BLACK



BB/PZ/WC



smart2lock

EDELSTAHL MATT  
STAINLESS STEEL MATT



BB/PZ/WC



smart2lock



**MODELL** 1 NORMTÜR NT-DA  
**OBERFLÄCHE** G-TEC® Weißlack Matt 9016  
**GLAS** -  
**ZARGE** KR1  
**BESCHLAG** QUATTRA INLAY, Graphitschwarz  
**MODEL** STANDARD DOOR NT-DA  
**FINISH** G-TEC® Matte White Varnish 9016  
**GLASS** -  
**FRAME** KR1  
**FITTINGS** QUATTRA INLAY, Graphite black

**2** NORMTÜR NT-LA11-DA  
G-TEC® Weißlack Matt 9016  
SATINATO, Standard-Ornamentglas  
KR1  
QUATTRA INLAY, Graphitschwarz  
STANDARD DOOR NT-LA11-DA  
G-TEC® Matte White Varnish 9016  
SATINATO, standard patterned glass  
KR1  
QUATTRA INLAY, Graphite black

**3** NORMTÜR NT-LA-DA  
G-TEC® Weißlack Matt 9016  
SATINATO, Standard-Ornamentglas  
KR1  
QUATTRA INLAY, Graphitschwarz  
STANDARD DOOR NT-LA-DA  
G-TEC® Matte White Varnish 9016  
SATINATO, standard patterned glass  
KR1  
QUATTRA INLAY, Graphite black

**4** NORMTÜR NT-LA-DA+SP4  
G-TEC® Weißlack Matt 9016  
SATINATO, Standard-Ornamentglas  
KR1  
QUATTRA INLAY, Graphitschwarz  
STANDARD DOOR NT-LA-DA+SP4  
G-TEC® Matte White Varnish 9016  
SATINATO, standard patterned glass  
KR1  
QUATTRA INLAY, Graphite black

**5** NORMTÜR NT-LA4S-DA  
G-TEC® Weißlack Matt 9016  
SATINATO, Standard-Ornamentglas  
KR1  
QUATTRA INLAY, Edelhloptik Matt  
STANDARD DOOR NT-LA4S-DA  
G-TEC® Matte White Varnish 9016  
SATINATO, standard patterned glass  
KR1  
QUATTRA INLAY, Matt stainless steel look

**6** NORMTÜR NT-LA4M-DA  
G-TEC® Weißlack Matt 9016  
SATINATO, Standard-Ornamentglas  
KR1  
QUATTRA INLAY, Edelhloptik Matt  
STANDARD DOOR NT-LA4M-DA  
G-TEC® Matte White Varnish 9016  
SATINATO, standard patterned glass  
KR1  
QUATTRA INLAY, Matt stainless steel look

**7** NORMTÜR NT-LA2-DA  
G-TEC® Weißlack Matt 9016  
PANNO, Design-Ornamentglas  
KR1  
QUATTRA INLAY, Edelhloptik Matt  
STANDARD DOOR NT-LA2-DA  
G-TEC® Matte White Varnish 9016  
PANNO, design patterned glass  
KR1  
QUATTRA INLAY, Matt stainless steel look



**JETZT TESTEN**  
Im Online-Türentool „DieTÜR“ von GARANT kombinieren Sie mit einfachen Klicks Ihre individuelle Wunschtür.  
**TEST NOW**  
Use GARANT's online door tool "DieTÜR" to create your own custom door in just a few clicks.





Hochmatte Oberfläche



Anti-Fingerprint



G-TEC® Weißlack Matt 9016  
G-TEC® Matte White Varnish 9016

Weißlacktüren mit hochmatter Oberfläche wirken in einem klassisch-urbanen Wohnambiente besonders edel und elegant. Ihre moderne Optik und die samtweiche Haptik verleihen Räumen das gewisse Extra. White varnish doors with an ultra-matte finish make an elegant addition to classic urban interiors. Their modern appearance and velvet-soft feel add a special touch to any room.





**NORMTÜREN**  
**G-TEC® Seidengrau Matt 7044**

STANDARD DOORS  
G-TEC® Matte Silk Grey 7044

Seidengrau strahlt Wärme und Wertigkeit zugleich aus. Kombiniert mit gedeckten Wandfarben und Holzfußböden ist diese Oberfläche der ideale Begleiter eines jungen Familien-Wohnstils.

Silk grey exudes both warmth and exclusivity. In combination with a neutral-coloured wall and wooden flooring, this door is perfect for a young family home environment.







**NORMTÜR**  
**G-TEC® Seidengrau Matt 7044**

Trendig aktuell für den jungen, frischen Wohnstil.

Trendy and modern for a young and fresh lifestyle.

Trotzt jedem Fingerabdruck.  
 Excellent anti-fingerprint properties.

**QUERSCHNITT | CROSS**

**KLEINE RUNDKANTE | SMALL ROUNDED EDGE**



**PREMIUMKANTE | PREMIUM EDGE**



**BESCHLAG**  
**NOVO**

**GRAPHITSCHWARZ**  
 GRAPHITE BLACK



BB/PZ/WC



smart2lock

**EDELSTAHL MATT**  
 STAINLESS STEEL MATT



BB/PZ/WC



smart2lock



**MODELL** 1 NORMTÜR NT-DA  
**OBERFLÄCHE** G-TEC® Seidengrau Matt 7044  
**GLAS** -  
**ZARGE** KR1  
**BESCHLAG** NOVO, Graphitschwarz  
**MODEL** STANDARD DOOR NT-DA  
**FINISH** G-TEC® Matte Silk Grey 7044  
**GLASS** -  
**FRAME** KR1  
**FITTINGS** NOVO, Graphite black

**MODELL** 2 NORMTÜR NT-LA11-DA  
**OBERFLÄCHE** G-TEC® Seidengrau Matt 7044  
**GLAS** SATINATO, Standard-Ornamentglas  
**ZARGE** KR1  
**BESCHLAG** NOVO, Graphitschwarz  
**MODEL** STANDARD DOOR NT-LA11-DA  
**FINISH** G-TEC® Matte Silk Grey 7044  
**GLASS** SATINATO, standard patterned glass  
**FRAME** KR1  
**FITTINGS** NOVO, Graphite black

**MODELL** 3 NORMTÜR NT-LA-DA  
**OBERFLÄCHE** G-TEC® Seidengrau Matt 7044  
**GLAS** SATINATO, Standard-Ornamentglas  
**ZARGE** KR1  
**BESCHLAG** NOVO, Graphitschwarz  
**MODEL** STANDARD DOOR NT-LA-DA  
**FINISH** G-TEC® Matte Silk Grey 7044  
**GLASS** SATINATO, standard patterned glass  
**FRAME** KR1  
**FITTINGS** NOVO, Graphite black

**MODELL** 4 NORMTÜR NT-LA-DA+SP4  
**OBERFLÄCHE** G-TEC® Seidengrau Matt 7044  
**GLAS** SATINATO, Standard-Ornamentglas  
**ZARGE** KR1  
**BESCHLAG** NOVO, Graphitschwarz  
**MODEL** STANDARD DOOR NT-LA-DA+SP4  
**FINISH** G-TEC® Matte Silk Grey 7044  
**GLASS** SATINATO, standard patterned glass  
**FRAME** KR1  
**FITTINGS** NOVO, Graphite black

**MODELL** 5 NORMTÜR NT-LA4S-DA  
**OBERFLÄCHE** G-TEC® Seidengrau Matt 7044  
**GLAS** SATINATO, Standard-Ornamentglas  
**ZARGE** KR1  
**BESCHLAG** NOVO, Edelstahl Matt  
**MODEL** STANDARD DOOR NT-LA4S-DA  
**FINISH** G-TEC® Matte Silk Grey 7044  
**GLASS** SATINATO, standard patterned glass  
**FRAME** KR1  
**FITTINGS** NOVO, Stainless steel matt

**MODELL** 6 NORMTÜR NT-LA4M-DA  
**OBERFLÄCHE** G-TEC® Seidengrau Matt 7044  
**GLAS** SATINATO, Standard-Ornamentglas  
**ZARGE** KR1  
**BESCHLAG** NOVO, Edelstahl Matt  
**MODEL** STANDARD DOOR NT-LA4M-DA  
**FINISH** G-TEC® Matte Silk Grey 7044  
**GLASS** SATINATO, standard patterned glass  
**FRAME** KR1  
**FITTINGS** NOVO, Stainless steel matt

**MODELL** 7 NORMTÜR NT-LA2-DA  
**OBERFLÄCHE** G-TEC® Seidengrau Matt 7044  
**GLAS** STRATO, Siebdruck-Veredelung  
**ZARGE** KR1  
**BESCHLAG** NOVO, Edelstahl Matt  
**MODEL** STANDARD DOOR NT-LA2-DA  
**FINISH** G-TEC® Matte Silk Grey 7044  
**GLASS** STRATO, screen printed décor  
**FRAME** KR1  
**FITTINGS** NOVO, Stainless steel matt



**JETZT TESTEN**  
 Im Online-Türentool „DieTÜR“ von GARANT kombinieren Sie mit einfachen Klicks Ihre individuelle Wunschtür.  
**TEST NOW**  
 Use GARANT's online door tool 'DieTÜR' to create your own custom door in just a few clicks.



MATT

Hochmatte Oberfläche



Anti-Fingerprint



G-TEC® Seidengrau Matt 7044  
G-TEC® Matte Silk Grey 7044

Für ein schönes Zuhause. Hochmattes Seidengrau wirkt elegant und doch natürlich entspannt.  
Mit diesen Türen werden Räume zur echten Wohlfühlzone für die ganze Familie.  
For a beautiful home. Ultra-matte silk grey has an elegant yet informal appearance.  
These doors turn rooms into genuine oases of well-being for the whole family.





**NORMTÜREN**  
**G-TEC® Staubgrau Matt 7037**

STANDARD DOORS  
G-TEC® Matte Dusty Grey 7037

Eine Oberfläche, die besonders in Kombination mit hohen Decken, Stuckleisten und edlen Holzböden überzeugt. Im modernen Altbau ist sie ein stilvoller Blickfang.

A finish that looks exceptionally good in combination with high ceilings, plaster cornices and fine wood flooring.

It is an eye-catching feature in any modernly-furnished old building.



NORMTÜR  
G-TEC® Staubgrau Matt 7037

Die klassisch-moderne  
Oberfläche in nobler Eleganz.

A classic-modern finish  
that exudes upmarket elegance.

Unterstreicht eine stilvolle Wohnkultur.  
Underlining the stylish interior.

QUERSCHNITT | CROSS

KLEINE RUNDKANTE | SMALL ROUNDED EDGE



PREMIUMKANTE | PREMIUM EDGE



BESCHLAG  
MONO

GRAPHITSCHWARZ  
GRAPHITE BLACK



BB/PZ/WC



smart2lock

EDELSTAHL MATT  
STAINLESS STEEL MATT



BB/PZ/WC



smart2lock



**MODELL** 1 NORMTÜR NT-DA  
**OBERFLÄCHE** G-TEC® Staubgrau Matt 7037  
**GLAS** -  
**ZARGE** KR1  
**BESCHLAG** MONO, Graphitschwarz  
**MODEL** STANDARD DOOR NT-DA  
**FINISH** G-TEC® Matte Dusty Grey 7037  
**GLASS** -  
**FRAME** KR1  
**FITTINGS** MONO, Graphite black

**MODELL** 2 NORMTÜR NT-LA11-DA  
**OBERFLÄCHE** G-TEC® Staubgrau Matt 7037  
**GLAS** SATINATO, Standard-Ornamentglas  
**ZARGE** KR1  
**BESCHLAG** MONO, Graphitschwarz  
**MODEL** STANDARD DOOR NT-LA11-DA  
**FINISH** G-TEC® Matte Dusty Grey 7037  
**GLASS** SATINATO, standard patterned glass  
**FRAME** KR1  
**FITTINGS** MONO, Graphite black

**MODELL** 3 NORMTÜR NT-LA-DA  
**OBERFLÄCHE** G-TEC® Staubgrau Matt 7037  
**GLAS** SATINATO, Standard-Ornamentglas  
**ZARGE** KR1  
**BESCHLAG** MONO, Graphitschwarz  
**MODEL** STANDARD DOOR NT-LA-DA  
**FINISH** G-TEC® Matte Dusty Grey 7037  
**GLASS** SATINATO, standard patterned glass  
**FRAME** KR1  
**FITTINGS** MONO, Graphite black

**MODELL** 4 NORMTÜR NT-LA-DA+SP4  
**OBERFLÄCHE** G-TEC® Staubgrau Matt 7037  
**GLAS** SATINATO, Standard-Ornamentglas  
**ZARGE** KR1  
**BESCHLAG** MONO, Graphitschwarz  
**MODEL** STANDARD DOOR NT-LA-DA+SP4  
**FINISH** G-TEC® Matte Dusty Grey 7037  
**GLASS** SATINATO, standard patterned glass  
**FRAME** KR1  
**FITTINGS** MONO, Graphite black

**MODELL** 5 NORMTÜR NT-LA4S-DA  
**OBERFLÄCHE** G-TEC® Staubgrau Matt 7037  
**GLAS** SATINATO, Standard-Ornamentglas  
**ZARGE** KR1  
**BESCHLAG** MONO, Edelstahl Matt  
**MODEL** STANDARD DOOR NT-LA4S-DA  
**FINISH** G-TEC® Matte Dusty Grey 7037  
**GLASS** SATINATO, standard patterned glass  
**FRAME** KR1  
**FITTINGS** MONO, Stainless steel matt

**MODELL** 6 NORMTÜR NT-LA4M-DA  
**OBERFLÄCHE** G-TEC® Staubgrau Matt 7037  
**GLAS** SATINATO, Standard-Ornamentglas  
**ZARGE** KR1  
**BESCHLAG** MONO, Edelstahl Matt  
**MODEL** STANDARD DOOR NT-LA4M-DA  
**FINISH** G-TEC® Matte Dusty Grey 7037  
**GLASS** SATINATO, standard patterned glass  
**FRAME** KR1  
**FITTINGS** MONO, Stainless steel matt

**MODELL** 7 NORMTÜR NT-LA2-DA  
**OBERFLÄCHE** G-TEC® Staubgrau Matt 7037  
**GLAS** PETALI, Design-Ornamentglas  
**ZARGE** KR1  
**BESCHLAG** MONO, Edelstahl Matt  
**MODEL** STANDARD DOOR NT-LA2-DA  
**FINISH** G-TEC® Matte Dusty Grey 7037  
**GLASS** PETALI, design patterned glass  
**FRAME** KR1  
**FITTINGS** MONO, Stainless steel matt



**JETZT TESTEN**  
Im Online-Türentool „DieTÜR“ von GARANT kombinieren Sie mit einfachen Klicks Ihre individuelle Wunschtür.  
**TEST NOW**  
Use GARANT's online door tool "DieTÜR" to create your own custom door in just a few clicks.





MATT

Hochmatte Oberfläche



Anti-Fingerprint



G-TEC® Staubgrau Matt 7037  
G-TEC® Matte Dusty Grey 7037

Der kühle Grauton wirkt edel und doch neutral. Mit ihrer besonderen Ästhetik und samtig-weichen Haptik setzen diese Oberflächen die richtigen Akzente in der Raumgestaltung – von traditionell bis klassisch-modern. Cool dusty grey creates an elegant and neutral setting. Aesthetic appearance and a velvet-soft feel make these doors the highlights of any interior design concept – from traditional to classic-modern.



**NORMTÜREN**  
**G-TEC® Graphitgrau Matt 7024**  
STANDARD DOORS  
G-TEC® Matte Graphite Grey 7024

Die Türoberflächen aus kühlem Graphitgrau stehen für Klarheit und Ruhe und sind in jeder Arbeitsumgebung die perfekte Ausstattung.  
The door finishes in cool graphite grey represent clarity and tranquillity; and they are perfect for any work environment.







**NORMTÜR**  
**G-TEC® Graphitgrau Matt 7024**

Ein klares Designstatement  
für das Office-Ambiente.

A distinctive office design  
statement.

Strahlkraft und Modernität in edlem Grau.  
A beautiful and charismatic modern grey.

**QUERSCHNITT | CROSS**

**KLEINE RUNDKANTE | SMALL ROUNDED EDGE**



**PREMIUMKANTE | PREMIUM EDGE**

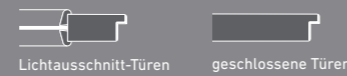

**BESCHLAG**  
**CUBO**

**GRAPHITSCHWARZ**  
**GRAPHITE BLACK**

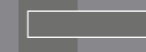

BB/PZ/WC



smart2lock

**EDELSTAHL MATT**  
**STAINLESS STEEL MATT**



BB/PZ/WC



smart2lock



**1** **NORMTÜR NT-DA**  
G-TEC® Graphitgrau Matt 7024  
-  
**GLAS**  
KR1  
**ZARGE**  
CUBO, Graphitschwarz  
**MODEL**  
STANDARD DOOR NT-DA  
**FINISH**  
G-TEC® Matte Graphite Grey 7024  
**GLASS**  
-  
**FRAME**  
KR1  
**FITTINGS**  
CUBO, Graphite black



**2** **NORMTÜR NT-LA11-DA**  
G-TEC® Graphitgrau Matt 7024  
SATINATO, Standard-Ornamentglas  
KR1  
CUBO, Graphitschwarz  
STANDARD DOOR NT-LA11-DA  
G-TEC® Matte Graphite Grey 7024  
SATINATO, standard patterned glass  
KR1  
CUBO, Graphite black



**3** **NORMTÜR NT-LA-DA**  
G-TEC® Graphitgrau Matt 7024  
SATINATO, Standard-Ornamentglas  
KR1  
CUBO, Graphitschwarz  
STANDARD DOOR NT-LA-DA  
G-TEC® Matte Graphite Grey 7024  
SATINATO, standard patterned glass  
KR1  
CUBO, Graphite black



**4** **NORMTÜR NT-LA-DA+SP4**  
G-TEC® Graphitgrau Matt 7024  
SATINATO, Standard-Ornamentglas  
KR1  
CUBO, Graphitschwarz  
STANDARD DOOR NT-LA-DA+SP4  
G-TEC® Matte Graphite Grey 7024  
SATINATO, standard patterned glass  
KR1  
CUBO, Graphite black

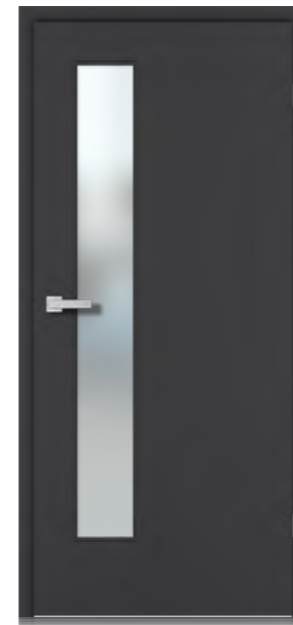

**5** **NORMTÜR NT-LA4S-DA**  
G-TEC® Graphitgrau Matt 7024  
SATINATO, Standard-Ornamentglas  
KR1  
CUBO, Edelstahl Matt  
STANDARD DOOR NT-LA4S-DA  
G-TEC® Matte Graphite Grey 7024  
SATINATO, standard patterned glass  
KR1  
CUBO, Stainless steel matt



**6** **NORMTÜR NT-LA4M-DA**  
G-TEC® Graphitgrau Matt 7024  
SATINATO, Standard-Ornamentglas  
KR1  
CUBO, Edelstahl Matt  
STANDARD DOOR NT-LA4M-DA  
G-TEC® Matte Graphite Grey 7024  
SATINATO, standard patterned glass  
KR1  
CUBO, Stainless steel matt



**7** **NORMTÜR NT-LA2-DA**  
G-TEC® Graphitgrau Matt 7024  
STRIPES-DA, Siebdruck-Veredelung  
KR1  
CUBO, Edelstahl Matt  
STANDARD DOOR NT-LA2-DA  
G-TEC® Matte Graphite Grey 7024  
STRIPES-DA, screen printed décor  
KR1  
CUBO, Stainless steel matt



**JETZT TESTEN**  
Im Online-Türentool „DieTÜR“ von GARANT kombinieren Sie mit einfachen Klicks Ihre individuelle Wunschtür.  
**TEST NOW**  
Use GARANT's online door tool 'DieTÜR' to create your own custom door in just a few clicks.





MATT

Hochmatte Oberfläche



Anti-Fingerprint



G-TEC® Graphitgrau Matt 7024  
G-TEC® Matte Graphite Grey 7024

Für ein stilvolles Office-Setting im schönsten Graphit-Design. Die grauen, hochmatten Oberflächen zeigen sich edel und strapazierfähig zugleich. Auch viele Hände hinterlassen hier keine störenden Spuren.  
For a stylish office setting in a beautiful graphite design. The grey, ultra-matte finishes are both elegant and hard-wearing. It makes no difference how many hands they come into contact with, there are never any annoying marks.





**NORMTÜREN**  
**G-TEC® Schwarz Matt 9005**

STANDARD DOORS  
G-TEC® Matte Black 9005

Mattes Schwarz entfaltet seine klare Wirkung in Kombination mit Holz und gedeckten Tönen. Eine Oberfläche mit Format und zeitloser Eleganz.

Matte black looks absolutely stunning in combination with wood and subdued shades. A finish with substance and timeless elegance.





NORMTÜR  
G-TEC® Schwarz Matt 9005

Stilprägend für  
modernes Wohnen.

Distinctive style  
for modern living.

Die edle Note in Mattschwarz.  
An elegant touch in matte black.

QUERSCHNITT | CROSS

KLEINE RUNDKANTE | SMALL ROUNDED EDGE



PREMIUMKANTE | PREMIUM EDGE



BESCHLAG  
CUBO

GRAPHITSCHWARZ  
GRAPHITE BLACK



BB/PZ/WC



smart2lock

EDELSTAHL MATT  
STAINLESS STEEL MATT



BB/PZ/WC



smart2lock

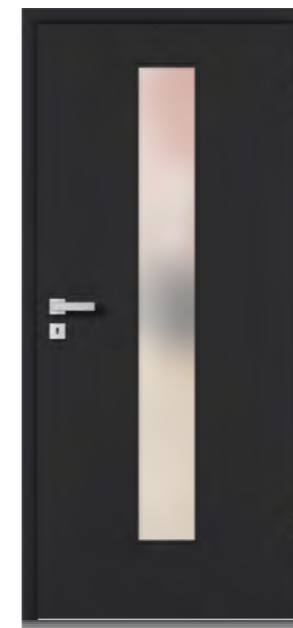

**MODELL** 1 NORMTÜR NT-DA  
**OBERFLÄCHE** G-TEC® Schwarz Matt 9005  
**GLAS** -  
**ZARGE** KR1  
**BESCHLAG** CUBO, Graphitschwarz  
**MODEL** STANDARD DOOR NT-DA  
**FINISH** G-TEC® Matte Black 9005  
**GLASS** -  
**FRAME** KR1  
**FITTINGS** CUBO, Graphite black

**2** NORMTÜR NT-LA11-DA  
G-TEC® Schwarz Matt 9005  
SATINATO, Standard-Ornamentglas  
KR1  
CUBO, Graphitschwarz  
STANDARD DOOR NT-LA11-DA  
G-TEC® Matte Black 9005  
SATINATO, standard patterned glass  
KR1  
CUBO, Graphite black

**3** NORMTÜR NT-LA-DA  
G-TEC® Schwarz Matt 9005  
SATINATO, Standard-Ornamentglas  
KR1  
CUBO, Graphitschwarz  
STANDARD DOOR NT-LA-DA  
G-TEC® Matte Black 9005  
SATINATO, standard patterned glass  
KR1  
CUBO, Graphite black

**4** NORMTÜR NT-LA-DA+SP4  
G-TEC® Schwarz Matt 9005  
SATINATO, Standard-Ornamentglas  
KR1  
CUBO, Graphitschwarz  
STANDARD DOOR NT-LA-DA+SP4  
G-TEC® Matte Black 9005  
SATINATO, standard patterned glass  
KR1  
CUBO, Graphite black

**5** NORMTÜR NT-LA4S-DA  
G-TEC® Schwarz Matt 9005  
SATINATO, Standard-Ornamentglas  
KR1  
CUBO, Edelstahl Matt  
STANDARD DOOR NT-LA4S-DA  
G-TEC® Matte Black 9005  
SATINATO, standard patterned glass  
KR1  
CUBO, Stainless steel matt

**6** NORMTÜR NT-LA4M-DA  
G-TEC® Schwarz Matt 9005  
SATINATO, Standard-Ornamentglas  
KR1  
CUBO, Edelstahl Matt  
STANDARD DOOR NT-LA4M-DA  
G-TEC® Matte Black 9005  
SATINATO, standard patterned glass  
KR1  
CUBO, Stainless steel matt

**7** NORMTÜR NT-LA2-DA  
G-TEC® Schwarz Matt 9005  
PANNO, Siebdruck-Veredelung  
KR1  
CUBO, Edelstahl Matt  
STANDARD DOOR NT-LA2-DA  
G-TEC® Matte Black 9005  
PANNO, screen printed décor  
KR1  
CUBO, Stainless steel matt



**JETZT TESTEN**  
Im Online-Türentool „DieTÜR“ von GARANT kombinieren Sie mit einfachen Klicks Ihre individuelle Wunschtür.  
**TEST NOW**  
Use GARANT's online door tool 'DieTÜR' to create your own custom door in just a few clicks.





Hochmatte Oberfläche



Anti-Fingerprint



G-TEC® Schwarz Matt 9005  
G-TEC® Matte Black 9005

Das hat Stil: Hochmattes Schwarz ist im modern gestalteten Zuhause immer salonfähig.  
Ein echter „Touch of Class“ ganz ohne Anfälligkeit für störende Abdrücke auf den Oberflächen.  
That's style for you: ultra-matte black is never out of place in a modern home environment.  
A genuine touch of class with zero susceptibility to annoying surface smudges.

# Gesamtübersicht NORMTÜREN-Programm

## Overview of the STANDARD DOOR range

NORMTÜREN | STANDARD DOORS

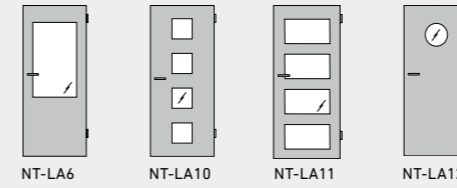
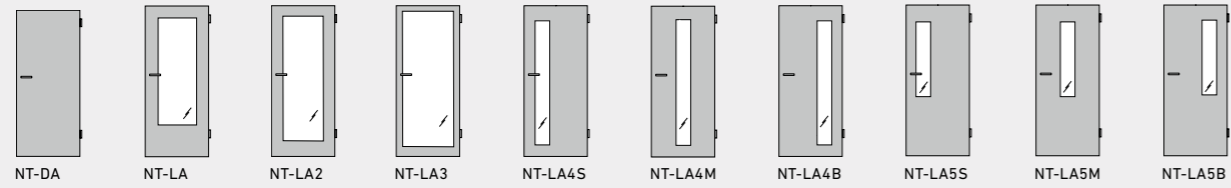

OBERFLÄCHEN | FINISHES



TÜRKANTEN | EDGES



GLÄSER | GLASS PANELS

### MODERNE ORNAMENTGLÄSER | MODERN PATTERNED GLASS PANELS

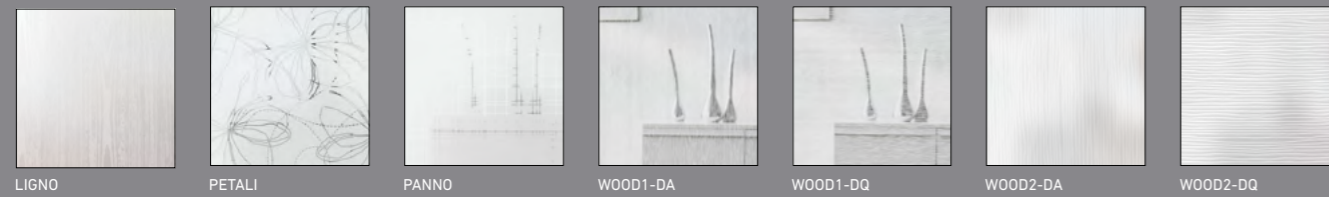

### DESIGNGLÄSER – SIEBDRUCK-VEREDELUNG | DESIGN GLASS PANELS – SCREEN PRINTED DÉCOR

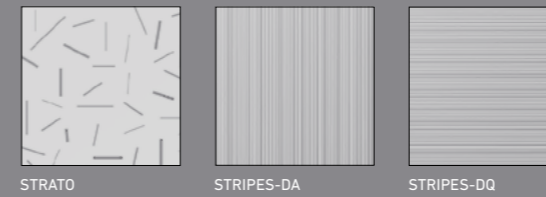

### KLASSISCHE ORNAMENTGLÄSER | CLASSIC PATTERNED GLASS PANELS



TOP-BESCHLÄGE | TOP-FERRURE

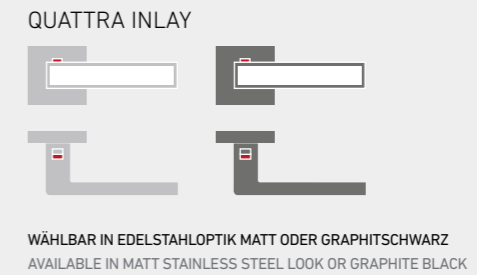
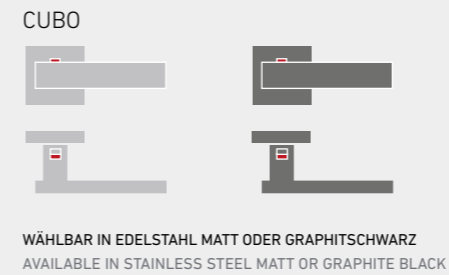
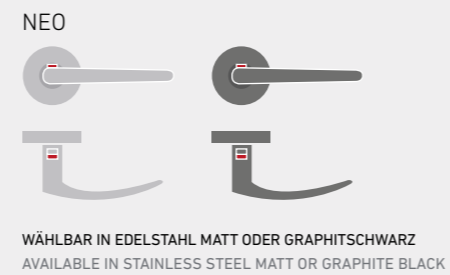
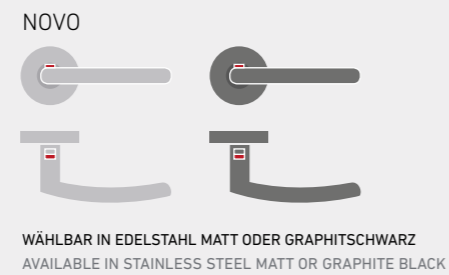
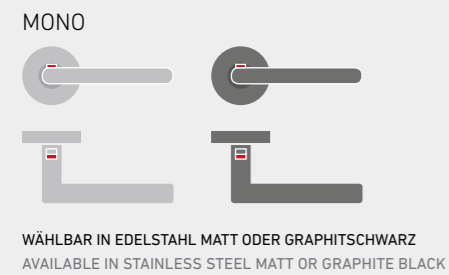

INLAYS | INLAYS





# Das DESIGNTÜREN-Programm

## The DESIGN DOOR range

### RAUM FÜR DESIGN

Mit den Modellen unseres DESIGNTÜREN-Programms werden Wohnwelten gestaltet.

### SPACE FOR DESIGN

The models in the DESIGN DOOR range can be used to create design worlds.



Anti-Fingerprint

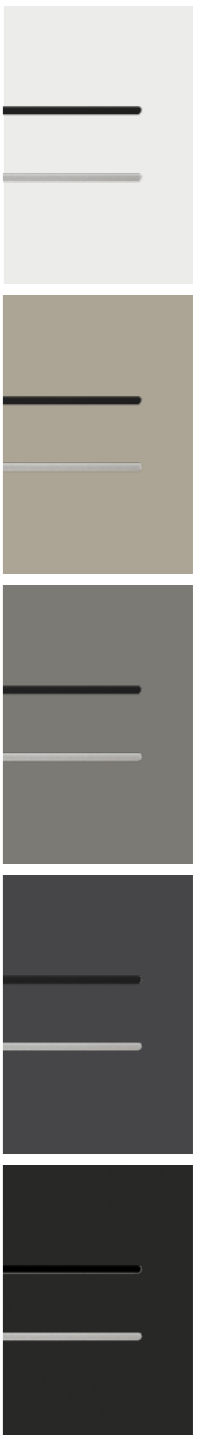





**DESIGNTÜREN**  
**AURA G-TEC® Weißlack Matt 9016**

DESIGN DOORS  
G-TEC® Matte White Varnish 9016

Hightech trifft urbanes Design: Die matte Weißlack-Oberfläche ist mit schwarzen oder Edelstahl-Lisenen das optische Highlight für den modernen City-Style.

High-tech meets urban design: the matte white varnish surface with black or stainless steel pilasters is a real highlight in any modern city-style setting.





AURA  
G-TEC® Weißlack Matt 9016

Hochmoderner Blickfang mit  
einzigartiger Designsprache.

An ultra-modern look with a unique  
design language.

Außergewöhnlich ansprechende Optik.  
And exceptional appeal.

QUERSCHNITT | CROSS

KLEINE RUNDKANTE | SMALL ROUNDED EDGE



PREMIUMKANTE | PREMIUM EDGE

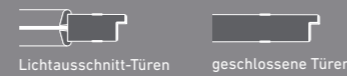

BESCHLAG  
CUBO

GRAPHITSCHWARZ  
GRAPHITE BLACK

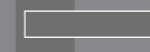

BB/PZ/WC



smart2lock

EDELSTAHL MATT  
STAINLESS STEEL MATT



BB/PZ/WC



smart2lock



**MODELL** 1 AURA A830  
**OBERFLÄCHE** G-TEC® Weißlack Matt 9016  
**GLAS** -  
**ZARGE** KR1  
**BESCHLAG** CUBO, Graphitschwarz  
**MODEL** AURA A830  
**FINISH** G-TEC® Matte White Varnish 9016  
**GLASS** -  
**FRAME** KR1  
**FITTINGS** CUBO, Graphite black

**MODELL** 2 AURA A830-LA4M  
**OBERFLÄCHE** G-TEC® Weißlack Matt 9016  
**GLAS** SATINATO, Standard-Ornamentglas  
**ZARGE** KR1  
**BESCHLAG** CUBO, Graphitschwarz  
**MODEL** AURA A830-LA4M  
**FINISH** G-TEC® Matte White Varnish 9016  
**GLASS** SATINATO, standard patterned glass  
**FRAME** KR1  
**FITTINGS** CUBO, Graphite black

**MODELL** 3 AURA A834  
**OBERFLÄCHE** G-TEC® Weißlack Matt 9016  
**GLAS** -  
**ZARGE** KR1  
**BESCHLAG** CUBO, Graphitschwarz  
**MODEL** AURA A834  
**FINISH** G-TEC® Matte White Varnish 9016  
**GLASS** -  
**FRAME** KR1  
**FITTINGS** CUBO, Graphite black

**MODELL** 4 AURA A834-LA4S  
**OBERFLÄCHE** G-TEC® Weißlack Matt 9016  
**GLAS** SATINATO, Standard-Ornamentglas  
**ZARGE** KR1  
**BESCHLAG** CUBO, Graphitschwarz  
**MODEL** AURA A834-LA4S  
**FINISH** G-TEC® Matte White Varnish 9016  
**GLASS** SATINATO, standard patterned glass  
**FRAME** KR1  
**FITTINGS** CUBO, Graphite black

**MODELL** 5 AURA A850  
**OBERFLÄCHE** G-TEC® Weißlack Matt 9016  
**GLAS** -  
**ZARGE** KR1  
**BESCHLAG** CUBO, Edelstahl Matt  
**MODEL** AURA A850  
**FINISH** G-TEC® Matte White Varnish 9016  
**GLASS** -  
**FRAME** KR1  
**FITTINGS** CUBO, Stainless steel matt

**MODELL** 6 AURA A851  
**OBERFLÄCHE** G-TEC® Weißlack Matt 9016  
**GLAS** -  
**ZARGE** KR1  
**BESCHLAG** CUBO, Edelstahl Matt  
**MODEL** AURA A851  
**FINISH** G-TEC® Matte White Varnish 9016  
**GLASS** -  
**FRAME** KR1  
**FITTINGS** CUBO, Stainless steel matt

**MODELL** 7 AURA A831  
**OBERFLÄCHE** G-TEC® Weißlack Matt 9016  
**GLAS** -  
**ZARGE** KR1  
**BESCHLAG** CUBO, Edelstahl Matt  
**MODEL** AURA A831  
**FINISH** G-TEC® Matte White Varnish 9016  
**GLASS** -  
**FRAME** KR1  
**FITTINGS** CUBO, Stainless steel matt



**JETZT TESTEN**  
Im Online-Türentool „DieTÜR“ von GARANT kombinieren Sie mit einfachen Klicks Ihre individuelle Wunschtür.  
**TEST NOW**  
Use GARANT's online door tool 'DieTÜR' to create your own custom door in just a few clicks.

Lisene Matt-Schwarz

Lisene Edelstahloptik



Hochmatte Oberfläche



Anti-Fingerprint



AURA G-TEC® Weißlack Matt 9016  
AURA G-TEC® Matte White Varnish 9016

Diese Design-Oberfläche ist ein starkes Statement für die wertige Raumgestaltung im Arbeitsumfeld oder Homeoffice. Quer laufende Lisenen sind hier extravaganter Blickfang.

This design finish makes a strong statement in an exclusive living or work environment. Transverse pilaster strips add a distinctively extravagant detail.





**DESIGNTÜREN**  
**AURA G-TEC® Seidengrau Matt 7044**

DESIGN DOORS  
AURA G-TEC® Matte Silk Grey 7044

Die seidengraue Oberfläche mit Matt-Schwarzen- oder Edelstahl-Lisenen ist die perfekte Design-Kombination für den klassisch-modernen Wohnstil mit gedeckten Farben und Holztönen.

The silk grey finish with matte-black or stainless steel pilaster strips is the perfect design formula for a classic-modern living environment with muted colour schemes and wood features.





AURA  
G-TEC® Seidengrau Matt 7044

Besticht in der Kombination  
mit erdigen Naturtönen.

Captivating in combination with  
natural earthy shades.

Warme Atmosphäre auf der ganzen Linie.  
A warm atmosphere through and through.

QUERSCHNITT | CROSS

KLEINE RUNDKANTE | SMALL ROUNDED EDGE

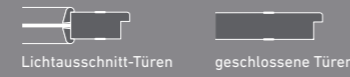

PREMIUMKANTE | PREMIUM EDGE

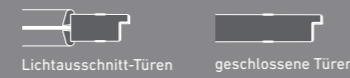

BESCHLAG  
NOVO

GRAPHITSCHWARZ  
GRAPHITE BLACK



BB/PZ/WC



smart2lock

EDELSTAHL MATT  
STAINLESS STEEL MATT



BB/PZ/WC



smart2lock



<b>MODELL</b>	1 AURA A832
<b>OBERFLÄCHE</b>	G-TEC® Seidengrau Matt 7044
<b>GLAS</b>	-
<b>ZARGE</b>	KR1
<b>BESCHLAG</b>	NOVO, Graphitschwarz
<b>MODEL</b>	AURA A832
<b>FINISH</b>	G-TEC® Matte Silk Grey 7044
<b>GLASS</b>	-
<b>FRAME</b>	KR1
<b>FITTINGS</b>	NOVO, Graphite black

<b>MODELL</b>	2 AURA A832-LA4M
<b>OBERFLÄCHE</b>	G-TEC® Seidengrau Matt 7044
<b>GLAS</b>	SATINATO, Standard-Ornamentglas
<b>ZARGE</b>	KR1
<b>BESCHLAG</b>	NOVO, Graphitschwarz
<b>MODEL</b>	AURA A832-LA4M
<b>FINISH</b>	G-TEC® Matte Silk Grey 7044
<b>GLASS</b>	SATINATO, standard patterned glass
<b>FRAME</b>	KR1
<b>FITTINGS</b>	NOVO, Graphite black

<b>MODELL</b>	3 AURA A834
<b>OBERFLÄCHE</b>	G-TEC® Seidengrau Matt 7044
<b>GLAS</b>	-
<b>ZARGE</b>	KR1
<b>BESCHLAG</b>	NOVO, Graphitschwarz
<b>MODEL</b>	AURA A834
<b>FINISH</b>	G-TEC® Matte Silk Grey 7044
<b>GLASS</b>	-
<b>FRAME</b>	KR1
<b>FITTINGS</b>	NOVO, Graphite black

<b>MODELL</b>	4 AURA A834-LA4S
<b>OBERFLÄCHE</b>	G-TEC® Seidengrau Matt 7044
<b>GLAS</b>	SATINATO, Standard-Ornamentglas
<b>ZARGE</b>	KR1
<b>BESCHLAG</b>	NOVO, Graphitschwarz
<b>MODEL</b>	AURA A834-LA4S
<b>FINISH</b>	G-TEC® Matte Silk Grey 7044
<b>GLASS</b>	SATINATO, standard patterned glass
<b>FRAME</b>	KR1
<b>FITTINGS</b>	NOVO, Graphite black

<b>MODELL</b>	5 AURA A850
<b>OBERFLÄCHE</b>	G-TEC® Seidengrau Matt 7044
<b>GLAS</b>	-
<b>ZARGE</b>	KR1
<b>BESCHLAG</b>	NOVO, Edelstahl Matt
<b>MODEL</b>	AURA A850
<b>FINISH</b>	G-TEC® Matte Silk Grey 7044
<b>GLASS</b>	-
<b>FRAME</b>	KR1
<b>FITTINGS</b>	NOVO, Stainless steel matt

<b>MODELL</b>	6 AURA A851
<b>OBERFLÄCHE</b>	G-TEC® Seidengrau Matt 7044
<b>GLAS</b>	-
<b>ZARGE</b>	KR1
<b>BESCHLAG</b>	NOVO, Edelstahl Matt
<b>MODEL</b>	AURA A851
<b>FINISH</b>	G-TEC® Matte Silk Grey 7044
<b>GLASS</b>	-
<b>FRAME</b>	KR1
<b>FITTINGS</b>	NOVO, Stainless steel matt

<b>MODELL</b>	7 AURA A831
<b>OBERFLÄCHE</b>	G-TEC® Seidengrau Matt 7044
<b>GLAS</b>	-
<b>ZARGE</b>	KR1
<b>BESCHLAG</b>	NOVO, Edelstahl Matt
<b>MODEL</b>	AURA A831
<b>FINISH</b>	G-TEC® Matte Silk Grey 7044
<b>GLASS</b>	-
<b>FRAME</b>	KR1
<b>FITTINGS</b>	NOVO, Stainless steel matt



**JETZT TESTEN**  
Im Online-Türentool „DieTÜR“ von GARANT kombinieren Sie mit einfachen Klicks Ihre individuelle Wunschtür.  
**TEST NOW**  
Use GARANT's online door tool 'DieTÜR' to create your own custom door in just a few clicks.



Lisene Matt-Schwarz

Lisene Edelstahloptik

MATT

Hochmatte Oberfläche



Anti-Fingerprint



AURA G-TEC® Seidengrau Matt 7044  
AURA G-TEC® Matte Silk Grey 7044

Im Stadthaus oder der Altbauwohnung steht die seidige Oberfläche mit ihrem warmen Farbton für ein edles, unaufdringliches Design, in dem man sich sofort zu Hause fühlt.

The silky finish with its warm colour tone immediately makes people feel at home and it is perfect for muted design scenarios in town houses or tastefully renovated apartments.



**DESIGNTÜREN**  
**AURA G-TEC® Staubgrau Matt 7037**

DESIGN DOORS  
AURA G-TEC® Matte Dusty Grey 7037

Auf der staubgrauen Oberfläche sind Matt-Schwarze- oder Edelstahl-Lisenen ein schicker Blickfang – auch im Design-Verbund mit verschiedenen Gläsern.

Matte black or stainless steel pilaster strips look stylish on a matte dusty grey finish, even with various glass panels.





AURA  
G-TEC® Staubgrau Matt 7037

Vielseitig auf der ganzen Linie  
und individuell kombinierbar.

Across-the-board versatility together  
with individual combinability.

Perfekt zu Grautönen und starken Farben.  
Perfect with grey shades and bold colours.

QUERSCHNITT | CROSS

KLEINE RUNDKANTE | SMALL ROUNDED EDGE



PREMIUMKANTE | PREMIUM EDGE



BESCHLAG  
MONO

GRAPHITSCHWARZ  
GRAPHITE BLACK



BB/PZ/WC

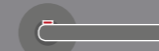

smart2lock

EDELSTAHL MATT  
STAINLESS STEEL MATT



BB/PZ/WC



smart2lock



**MODELL** 1 AURA A830  
**OBERFLÄCHE** G-TEC® Staubgrau Matt 7037  
**GLAS** -  
**ZARGE** KR1  
**BESCHLAG** MONO, Graphitschwarz  
**MODEL** AURA A830  
**FINISH** G-TEC® Matte Dusty Grey 7037  
**GLASS** -  
**FRAME** KR1  
**FITTINGS** MONO, Graphite black

**2** AURA A830-LA4M  
G-TEC® Staubgrau Matt 7037  
SATINATO, Standard-Ornamentglas  
KR1  
MONO, Graphitschwarz  
AURA A830-LA4M  
G-TEC® Matte Dusty Grey 7037  
SATINATO, standard patterned glass  
KR1  
MONO, Graphite black

**3** AURA A834  
G-TEC® Staubgrau Matt 7037  
-  
KR1  
MONO, Graphitschwarz  
AURA A834  
G-TEC® Matte Dusty Grey 7037  
-  
KR1  
MONO, Graphite black

**4** AURA A834-LA4S  
G-TEC® Staubgrau Matt 7037  
SATINATO, Standard-Ornamentglas  
KR1  
MONO, Graphitschwarz  
AURA A834-LA4S  
G-TEC® Matte Dusty Grey 7037  
SATINATO, standard patterned glass  
KR1  
MONO, Graphite black

**5** AURA A850  
G-TEC® Staubgrau Matt 7037  
-  
KR1  
MONO, Edelstahl Matt  
AURA A850  
G-TEC® Matte Dusty Grey 7037  
-  
KR1  
MONO, Stainless steel matt

**6** AURA A851  
G-TEC® Staubgrau Matt 7037  
-  
KR1  
MONO, Edelstahl Matt  
AURA A851  
G-TEC® Matte Dusty Grey 7037  
-  
KR1  
MONO, Stainless steel matt

**7** AURA A831  
G-TEC® Staubgrau Matt 7037  
-  
KR1  
MONO, Edelstahl Matt  
AURA A831  
G-TEC® Matte Dusty Grey 7037  
-  
KR1  
MONO, Stainless steel matt



**JETZT TESTEN**  
Im Online-Türentool „DieTÜR“ von GARANT kombinieren Sie mit einfachen Klicks Ihre individuelle Wunschtür.  
**TEST NOW**  
Use GARANT's online door tool "DieTÜR" to create your own custom door in just a few clicks.



Lisene Matt-Schwarz

Lisene Edelstahloptik

MATT

Hochmatte Oberfläche



Anti-Fingerprint



AURA G-TEC® Staubgrau Matt 7037  
AURA G-TEC® Matte Dusty Grey 7037

Die staubgraue Oberfläche entfaltet besondere Stärke im Kontrast mit anderen Farben.  
Im modernen Wohnambiente lässt sie sich hervorragend mit Grau- und Holztönen kombinieren.  
The dusty grey surface provides a wonderful contrast to other colours.  
Combined with grey and wood colours, the effect is beautiful in a modern interior setting.





**DESIGNTÜREN**  
**AURA G-TEC® Graphitgrau Matt 7024**

DESIGN DOORS  
AURA G-TEC® Matte Graphite Grey 7024

Ob modernes Büro oder trendiger Office-Space, Türoberflächen in Graphitgrau sind die Design-Option für die hochwertige, moderne Raumausstattung.

Graphite grey door finishes are the perfect design option for exclusive and modern offices or trendy work environments.





AURA  
G-TEC® Graphitgrau Matt 7024

Perfekt zu einer Möblierung  
mit Design-Klassikern.

Perfect in conjunction with classic  
designer furniture.

Hochwertiger Stil in edlem Design.  
Exclusive style meets elegant design.

QUERSCHNITT | CROSS

KLEINE RUNDKANTE | SMALL ROUNDED EDGE

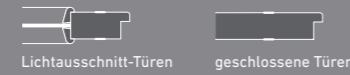

PREMIUMKANTE | PREMIUM EDGE



BESCHLAG  
QUATTRA INLAY

GRAPHITSCHWARZ  
GRAPHITE BLACK



BB/PZ/WC



smart2lock

EDELSTAHL MATT  
STAINLESS STEEL MATT



BB/PZ/WC



smart2lock



<b>MODELL</b>	1 AURA A830
<b>OBERFLÄCHE</b>	G-TEC® Graphitgrau Matt 7024
<b>GLAS</b>	-
<b>ZARGE</b>	KR1
<b>BESCHLAG</b>	QUATTRA INLAY, Graphitschwarz
<b>MODEL</b>	AURA A830
<b>FINISH</b>	G-TEC® Matte Graphite Grey 7024
<b>GLASS</b>	-
<b>FRAME</b>	KR1
<b>FITTINGS</b>	QUATTRA INLAY, Graphite black

<b>MODELL</b>	2 AURA A830-LA4M
<b>OBERFLÄCHE</b>	G-TEC® Graphitgrau Matt 7024
<b>GLAS</b>	SATINATO, Standard-Ornamentglas
<b>ZARGE</b>	KR1
<b>BESCHLAG</b>	QUATTRA INLAY, Graphitschwarz
<b>MODEL</b>	AURA A830-LA4M
<b>FINISH</b>	G-TEC® Matte Graphite Grey 7024
<b>GLASS</b>	SATINATO, standard patterned glass
<b>FRAME</b>	KR1
<b>FITTINGS</b>	QUATTRA INLAY, Graphite black

<b>MODELL</b>	3 AURA A834
<b>OBERFLÄCHE</b>	G-TEC® Graphitgrau Matt 7024
<b>GLAS</b>	-
<b>ZARGE</b>	KR1
<b>BESCHLAG</b>	QUATTRA INLAY, Graphitschwarz
<b>MODEL</b>	AURA A834
<b>FINISH</b>	G-TEC® Matte Graphite Grey 7024
<b>GLASS</b>	-
<b>FRAME</b>	KR1
<b>FITTINGS</b>	QUATTRA INLAY, Graphite black

<b>MODELL</b>	4 AURA A834-LA4S
<b>OBERFLÄCHE</b>	G-TEC® Graphitgrau Matt 7024
<b>GLAS</b>	SATINATO, Standard-Ornamentglas
<b>ZARGE</b>	KR1
<b>BESCHLAG</b>	QUATTRA INLAY, Graphitschwarz
<b>MODEL</b>	AURA A834-LA4S
<b>FINISH</b>	G-TEC® Matte Graphite Grey 7024
<b>GLASS</b>	SATINATO, standard patterned glass
<b>FRAME</b>	KR1
<b>FITTINGS</b>	QUATTRA INLAY, Graphite black

<b>MODELL</b>	5 AURA A850
<b>OBERFLÄCHE</b>	G-TEC® Graphitgrau Matt 7024
<b>GLAS</b>	-
<b>ZARGE</b>	KR1
<b>BESCHLAG</b>	QUATTRA INLAY, Edelstahloptik Matt
<b>MODEL</b>	AURA A850
<b>FINISH</b>	G-TEC® Matte Graphite Grey 7024
<b>GLASS</b>	-
<b>FRAME</b>	KR1
<b>FITTINGS</b>	QUATTRA INLAY, Matt stainless steel look

<b>MODELL</b>	6 AURA A851
<b>OBERFLÄCHE</b>	G-TEC® Graphitgrau Matt 7024
<b>GLAS</b>	-
<b>ZARGE</b>	KR1
<b>BESCHLAG</b>	QUATTRA INLAY, Edelstahloptik Matt
<b>MODEL</b>	AURA A851
<b>FINISH</b>	G-TEC® Matte Graphite Grey 7024
<b>GLASS</b>	-
<b>FRAME</b>	KR1
<b>FITTINGS</b>	QUATTRA INLAY, Matt stainless steel look

<b>MODELL</b>	7 AURA A831
<b>OBERFLÄCHE</b>	G-TEC® Graphitgrau Matt 7024
<b>GLAS</b>	-
<b>ZARGE</b>	KR1
<b>BESCHLAG</b>	QUATTRA INLAY, Edelstahloptik Matt
<b>MODEL</b>	AURA A831
<b>FINISH</b>	G-TEC® Matte Graphite Grey 7024
<b>GLASS</b>	-
<b>FRAME</b>	KR1
<b>FITTINGS</b>	QUATTRA INLAY, Matt stainless steel look



**JETZT TESTEN**  
Im Online-Türentool „DieTÜR“ von GARANT kombinieren Sie mit einfachen Klicks Ihre individuelle Wunschtür.  
**TEST NOW**  
Use GARANT's online door tool 'DieTÜR' to create your own custom door in just a few clicks.



Lisene Matt-Schwarz

Lisene Edelhloptik

MATT

Hochmatte Oberfläche



Anti-Fingerprint



AURA G-TEC® Graphitgrau Matt 7024  
AURA G-TEC® Matte Graphite Grey 7024

Die matte Oberfläche punktet im modernen Office-Ambiente durch edles Graphitgrau. Fingerabdrücke haben hier keine Chance.  
The matte finish in elegant graphite grey looks fabulous in a modern office environment. It is also a completely finger print-free zone.



**DESIGNTÜREN**  
**AURA G-TEC® Schwarz Matt 9005**

DESIGN DOORS  
AURA G-TEC® Matte Black 9005

Ein Star im Interior Design für zeitloses, hochwertiges Look & Feel  
im trendorientierten Wohn- oder Officebereich.

An interior design star with a timelessly elegant look & feel  
for trendy homes and offices





AURA  
G-TEC® Schwarz Matt 9005

Edles Entree für das vollendete Raumdesign.

An elegant entrée to perfect interior design.

Für den gehobenen Auftritt in Kombination mit Einrichtungsklassikern.  
For an upmarket look in combination with classical furnishings.

QUERSCHNITT | CROSS

KLEINE RUNDKANTE | SMALL ROUNDED EDGE

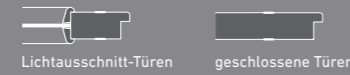

PREMIUMKANTE | PREMIUM EDGE



BESCHLAG  
QUATTRA INLAY

GRAPHITSCHWARZ  
GRAPHITE BLACK



BB/PZ/WC



smart2lock

EDELSTAHL MATT  
STAINLESS STEEL MATT



BB/PZ/WC



smart2lock



**MODELL** 1 AURA A830  
**OBERFLÄCHE** G-TEC® Schwarz Matt 9005  
**GLAS** -  
**ZARGE** KR1  
**BESCHLAG** QUATTRA INLAY, Graphitschwarz  
**MODEL** AURA A830  
**FINISH** G-TEC® Matte Black 9005  
**GLASS** -  
**FRAME** KR1  
**FITTINGS** QUATTRA INLAY, Graphite black

**MODELL** 2 AURA A830-LA4M  
**OBERFLÄCHE** G-TEC® Schwarz Matt 9005  
**GLAS** SATINATO, Standard-Ornamentglas  
**ZARGE** KR1  
**BESCHLAG** QUATTRA INLAY, Graphitschwarz  
**MODEL** AURA A830-LA4M  
**FINISH** G-TEC® Matte Black 9005  
**GLASS** SATINATO, standard patterned glass  
**FRAME** KR1  
**FITTINGS** QUATTRA INLAY, Graphite black

**MODELL** 3 AURA A834  
**OBERFLÄCHE** G-TEC® Schwarz Matt 9005  
**GLAS** -  
**ZARGE** KR1  
**BESCHLAG** QUATTRA INLAY, Graphitschwarz  
**MODEL** AURA A834  
**FINISH** G-TEC® Matte Black 9005  
**GLASS** -  
**FRAME** KR1  
**FITTINGS** QUATTRA INLAY, Graphite black

**MODELL** 4 AURA A834-LA4S  
**OBERFLÄCHE** G-TEC® Schwarz Matt 9005  
**GLAS** SATINATO, Standard-Ornamentglas  
**ZARGE** KR1  
**BESCHLAG** QUATTRA INLAY, Graphitschwarz  
**MODEL** AURA A834-LA4S  
**FINISH** G-TEC® Matte Black 9005  
**GLASS** SATINATO, standard patterned glass  
**FRAME** KR1  
**FITTINGS** QUATTRA INLAY, Graphite black

**MODELL** 5 AURA A850  
**OBERFLÄCHE** G-TEC® Schwarz Matt 9005  
**GLAS** -  
**ZARGE** KR1  
**BESCHLAG** QUATTRA INLAY, Edelstahloptik Matt  
**MODEL** AURA A850  
**FINISH** G-TEC® Matte Black 9005  
**GLASS** -  
**FRAME** KR1  
**FITTINGS** QUATTRA INLAY, Matt stainless steel look

**MODELL** 6 AURA A851  
**OBERFLÄCHE** G-TEC® Schwarz Matt 9005  
**GLAS** -  
**ZARGE** KR1  
**BESCHLAG** QUATTRA INLAY, Edelstahloptik Matt  
**MODEL** AURA A851  
**FINISH** G-TEC® Matte Black 9005  
**GLASS** -  
**FRAME** KR1  
**FITTINGS** QUATTRA INLAY, Matt stainless steel look

**MODELL** 7 AURA A831  
**OBERFLÄCHE** G-TEC® Schwarz Matt 9005  
**GLAS** -  
**ZARGE** KR1  
**BESCHLAG** QUATTRA INLAY, Edelstahloptik Matt  
**MODEL** AURA A831  
**FINISH** G-TEC® Matte Black 9005  
**GLASS** -  
**FRAME** KR1  
**FITTINGS** QUATTRA INLAY, Matt stainless steel look



**JETZT TESTEN**  
Im Online-Türentool „DieTÜR“ von GARANT kombinieren Sie mit einfachen Klicks Ihre individuelle Wunschtür.  
**TEST NOW**  
Use GARANT's online door tool "DieTÜR" to create your own custom door in just a few clicks.

Lisene Matt-Schwarz

Lisene Edelstahloptik



Hochmatte Oberfläche



Anti-Fingerprint



AURA G-TEC® Schwarz Matt 9005

AURA G-TEC® Matte Black 9005

Die perfekte Ausstattung im Designkonzept: silberglänzende Lisenen und Lichteinschnitte kombiniert mit schwarzen Oberflächen.

The perfect look for the design concept: shiny silver pilaster strips and glass panels in combination with black finishes.



# Gesamtübersicht DESIGNTÜREN-Programm

## Overview of the DESIGN DOOR range

AURA | AURA

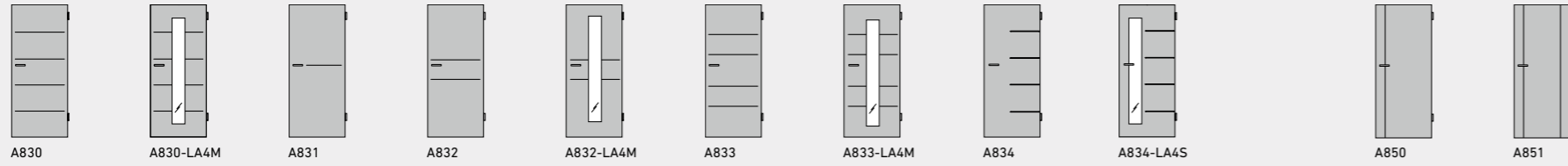

OBERFLÄCHEN | FINISHES



TÜRKANTEN | EDGES



GLÄSER | GLASS PANELS

### MODERNE ORNAMENTGLÄSER | MODERN PATTERNED GLASS PANELS

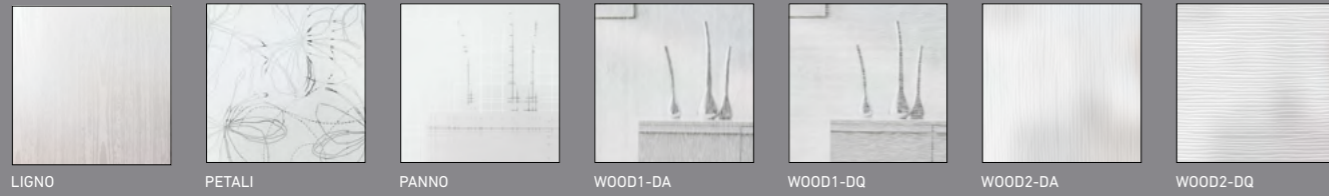

### DESIGNGLÄSER – SIEBDRUCK-VEREDELUNG | DESIGN GLASS PANELS – SCREEN PRINTED DÉCOR

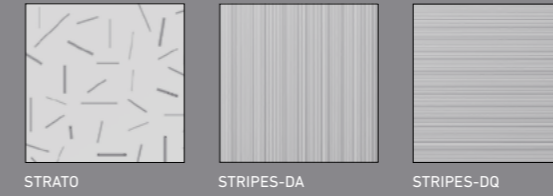

### KLASSISCHE ORNAMENTGLÄSER | CLASSIC PATTERNED GLASS PANELS



TOP-BESCHLÄGE | TOP-FERRURE

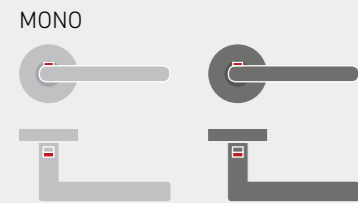

WÄHLBAR IN EDELSTAHL MATT ODER GRAPHITSCHWARZ  
AVAILABLE IN STAINLESS STEEL MATT OR GRAPHITE BLACK

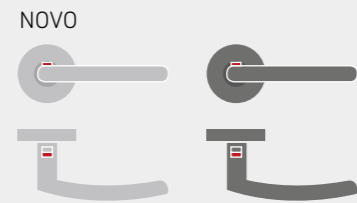

WÄHLBAR IN EDELSTAHL MATT ODER GRAPHITSCHWARZ  
AVAILABLE IN STAINLESS STEEL MATT OR GRAPHITE BLACK

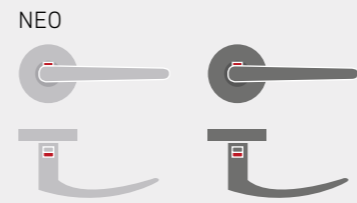

WÄHLBAR IN EDELSTAHL MATT ODER GRAPHITSCHWARZ  
AVAILABLE IN STAINLESS STEEL MATT OR GRAPHITE BLACK

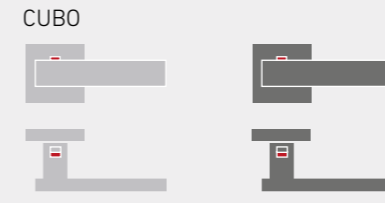

WÄHLBAR IN EDELSTAHL MATT ODER GRAPHITSCHWARZ  
AVAILABLE IN STAINLESS STEEL MATT OR GRAPHITE BLACK

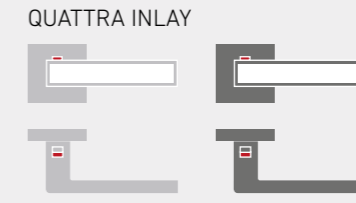

WÄHLBAR IN EDELSTAHOPTIK MATT ODER GRAPHITSCHWARZ  
AVAILABLE IN MATT STAINLESS STEEL LOOK OR GRAPHITE BLACK

INLAYS | INLAYS



# Elemente

## Elements

Beim Thema Türen sind wir in unserem Element und können Ihnen mit Sicherheit immer die richtigen Türelemente bieten. Unsere durchdachten Lösungen ermöglichen Ihnen die Umsetzung Ihrer individuellen Raumkonzepte.

We're in our element when it comes to the subject of doors, and we guarantee we can always provide you with the perfect door elements. Our clever solutions enable you to realise your personal interior design concepts.



WINDFANGELEMENTE UND SCHIEBETÜRLÖSUNGEN



DOPPELTÜREN (2-FLG. TÜREN)





## Windfangelemente und Schiebetürlösungen Draught-stop elements and sliding doors



### **SCHIEBETÜRBESCHLAG LINE**

Das schlanke Schiebetürsystem im Edelstahl-Design für Holz- und Ganzglastüren. LINE ist wahlweise auch mit Einzugsdämpfung (beidseitig) lieferbar.

### **LINE SLIDING DOOR FITTING**

The streamlined sliding door system in a stainless steel design for wood and all-glass doors is also available with an optional soft close function (both sides).



### **SCHIEBETÜRBESCHLAG BASIC – AUSFÜHRUNG „VOR DER WAND LAUFEND“**

Die gehobene Holzklasse, unser BASIC-Schiebetürbeschlag für Holz- und Ganzglastüren. Öffnen Sie Türen auf die klassische Art. BASIC ist wahlweise auch mit Einzugsdämpfung (ein- oder beidseitig) lieferbar.

### **BASIC SLIDING DOOR FITTING – ‘FRONT OF WALL’ VERSION**

Our BASIC sliding door fittings for wood and all-glass doors are premium hardware. Open the doors in the conventional way. BASIC is also available with an optional soft close function (one or both sides).

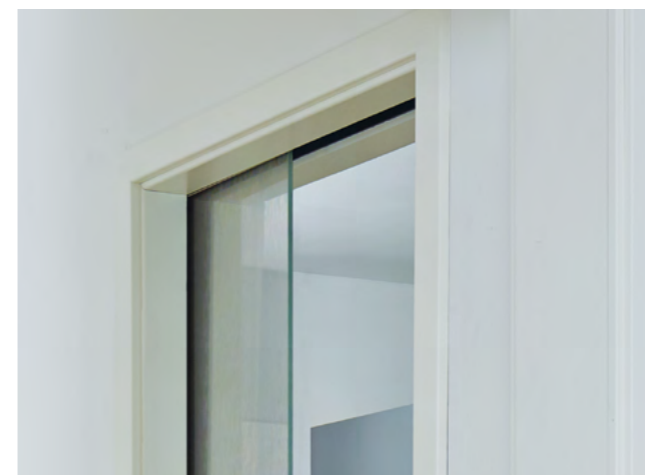

### **SCHIEBETÜRBESCHLAG BASIC – AUSFÜHRUNG „IN DER WAND LAUFEND“**

Innenlaufende Schiebetüren mit dem BASIC-Schiebetürbeschlag – egal ob als Holz- oder Ganzglastüren – sind die ideale Lösung, wenn es für normale Drehtüren in den verbundenen Räumen keinen Öffnungs- und Bewegungsraum gibt.

### **BASIC SLIDING DOOR FITTINGS – ‘IN-WALL’ VERSION**

In-wall sliding doors – both wood and glass models – with BASIC sliding door fittings are the ideal solution when there is no space for conventionally opening doors in connected rooms.



Windfangelemente und Schiebetürlösungen



# Schiebetürbeschlag LINE

## LINE sliding door fittings

Platzsparendes Design auch für kleine Räume.  
Space-saving design for small rooms.



### SCHIEBETÜRBESCHLAG LINE

Das schlanke Schiebetürsystem im Edelstahl-Design für Holz- und Ganzglastüren. LINE ist wahlweise auch mit Einzugsdämpfung (beidseitig) lieferbar.

### LINE SLIDING DOOR FITTINGS

The streamlined sliding door system in a stainless steel design for wood and all-glass doors is also available with an optional soft close function (both sides).

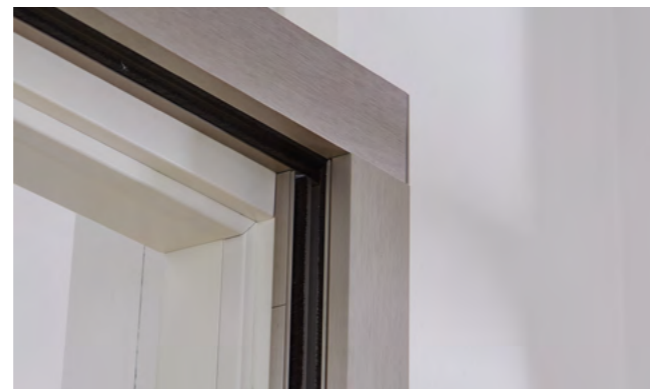

LINE mit Anschlagkasten



Befestigung einer Holztür im Schiebetürbeschlag LINE

# LINE-Schiebetürbeschlag mit Inlay

## LINE sliding door fitting with inlay

VIDEO Windfangelemente und Schiebetürlösungen  
Draught-stop elements and sliding doors

KLICK



In diesen Oberflächen erhältlich | Available in these finishes



WEISS 9010  
WHITE 9010



WEISS 9016  
WHITE 9016



SCHWARZ 9005  
BLACK 9005



Befestigung einer Ganzglastür im Schiebetürbeschlag LINE



LINE ohne Anschlagkasten





**VERDOPPELN SIE IHRE MÖGLICHKEITEN**

Mit unseren 2-flügeligen Türen sorgen Sie für mehr Großzügigkeit, Offenheit und Licht. So kommen Ihre Räume ganz groß heraus.

**DOUBLE YOUR POSSIBILITIES**

With our double-leaf doors you get more space, openness and light. They help you to maximise your room space.



NORMTÜR NT-DA, 2-flügelig, G-TEC® Weißlack Matt 9016



NORMTÜR NT-LA4M-DA 2-flügelig, Verglasung PETALI, G-TEC® Staubgrau Matt 7037



A832-LA4M 2-flügelig, Verglasung STRIPES DQ, G-TEC® Seidengrau Matt 7044



**Doppeltüren (2-flg.) | Double-leaf doors**

Großzügigkeit mal 2 | Twice the size



# Technische Details

## Technical details

### ENTDECKEN SIE UNSERE TÜRENDETAILS AUF EINEN BLICK

Eine Übersicht über Glasprogramm, Beschläge, Zargen und spezielle Funktionen.

### ALL THE DETAILS ABOUT OUR DOORS AT A GLANCE

An overview of the glass range, fittings, frames and special functions.

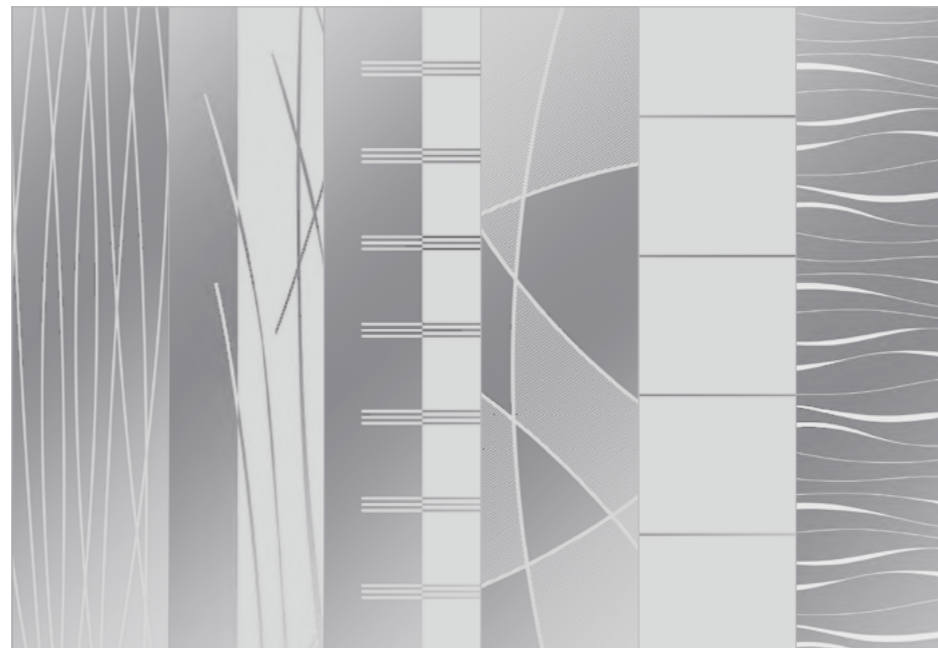
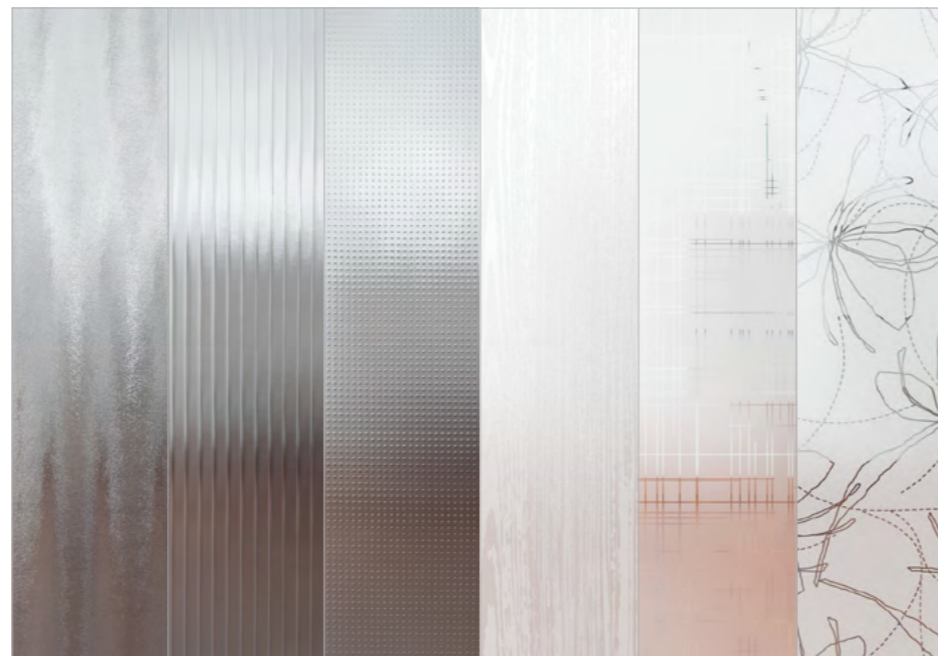



**GARANT-DESIGNVERBUND**  
Ornamentgläser als Ganzglastür  
und Lichteauschnittgläser erhältlich.

**GARANT DESIGN COMPOSITION**  
Patterned glass is available for  
doors and door panels.

# Ornamentglas für Ganzglastüren

## Patterned glass for all-glass doors

Moderne Ganzglastüren für raffinierte Lichtblicke.

Modern all-glass doors are a clever way to make rooms lighter.

### DESIGN-ORNAMENTGLAS | DESIGN PATTERNED GLASS

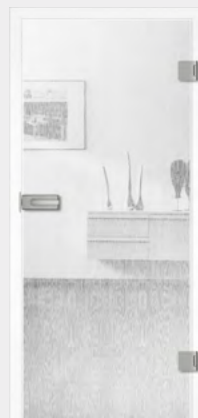

WOOD1-DA

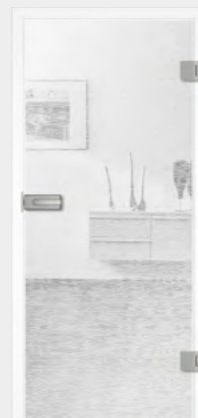

WOOD1-DQ



WOOD2-DA



WOOD2-DQ



LIGNO



PETALI



PANNO

### STANDARD-ORNAMENTGLAS | STANDARD PATTERNED GLASS



CHINCHILLA WEISS  
CHINCHILLA WHITE



MASTERLIGNÈ



MASTERPOINT



MASTERCARRÉ



KLARGLAS  
TRANSPARENT GLASS



SATINATO

**GARANT-DESIGNVERBUND**  
Ornamentgläser als Ganzglastür  
und Lichtausschnittgläser erhältlich.

**GARANT DESIGN COMPOSITION**  
Patterned glass is available for  
doors and door panels.

# Ornamentglas für Lichtausschnitt-Türen

## Patterned glass for doors with panels

Wählen Sie Transparenz.  
Choose transparency.

### DESIGN-ORNAMENTGLAS | DESIGN PATTERNED GLASS



WOOD1-DA



WOOD1-DQ

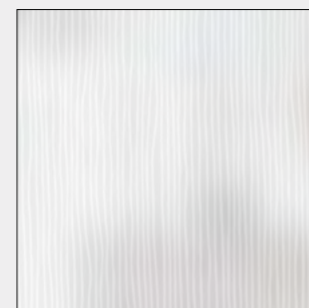

WOOD2-DA



WOOD2-DQ

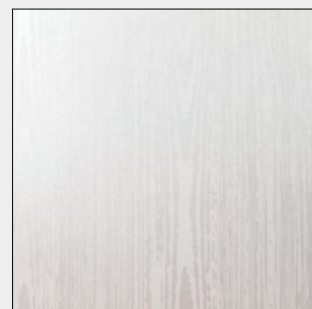

LIGNO

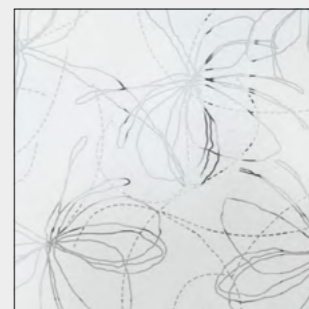

PETALI

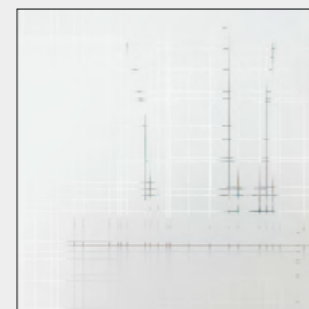

PANNO

### STANDARD-ORNAMENTGLAS | STANDARD PATTERNED GLASS

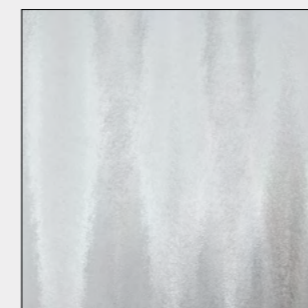

CHINCHILLA WEISS  
CHINCHILLA WHITE

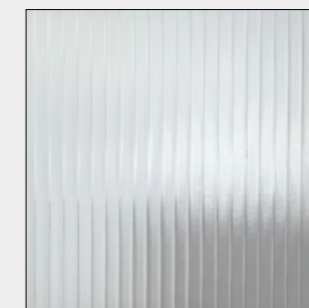

MASTERLIGNÈ



MASTERPOINT



MASTERCARRÉ

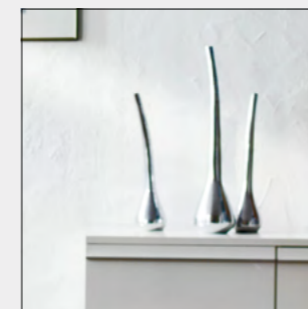

KLARGLAS  
TRANSPARENT GLASS

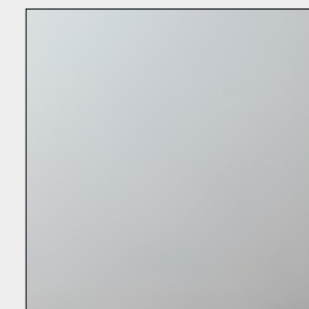

SATINATO



**GARANT-DESIGNVERBUND**  
 Designglas motive als Ganzglastür  
 und Lichtausschnittgläser erhältlich.

**GARANT DESIGN COMPOSITION**  
 Design glass motifs are available  
 for all-glass doors and door panels.

# Designglas für Ganzglastüren

## Design patterned glass for all-glass doors

Transparenz mit edlem Charakter.  
 Elegant transparency.

### SIEBDRUCK-VEREDELUNG | SCREEN PRINTED DÉCOR



LINEUM



LINUS



SEVENTY



BAMBUS



FREE



LIPSO



DESIGN R11.1



DESIGN R11.2



DESIGN R14.1



DESIGN R18.1



DESIGN R110.1

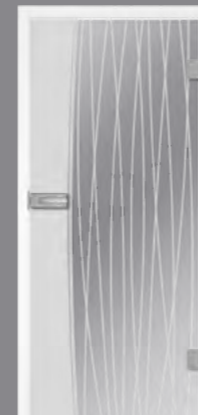

ACCORDIA



DESIGN R111.1

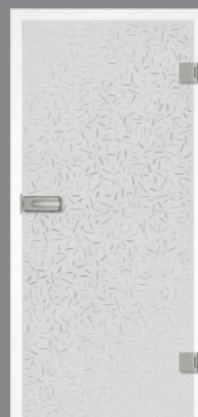

STRATO



STRIPES DA



STRIPES DQ

### LASER-VEREDELUNG | LASER DÉCOR



ARPA



PALLA



FIORE



SAGI



ONDA 1



ONDA 2



MOTUS



FLORA 1



FLORA 2



CENTRO



LINEA 1

# Designglas für Lichtausschnitt-Türen

## Design patterned glass for doors with panels

Weil ich einzigartigen Durchblick will.  
 Because I want unique vision.

### SIEBDRUCK-VEREDELUNG | SCREEN PRINTED DÉCOR



LINEUM



LINUS



SEVENTY



BAMBUS



FREE



LIPSO

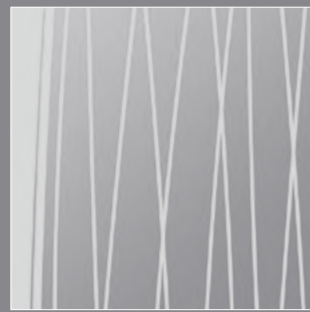

ACCORDIA



LINEA 1

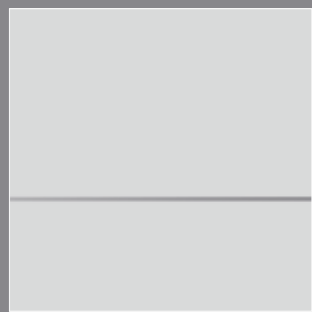

DESIGN RI1.1

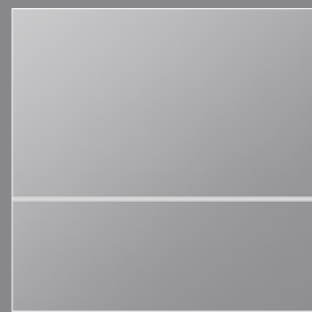

DESIGN RI1.2



STRATO



STRIPES DA/DQ

### LASER-VEREDELUNG | LASER DÉCOR



ARPA



PALLA



FIORE

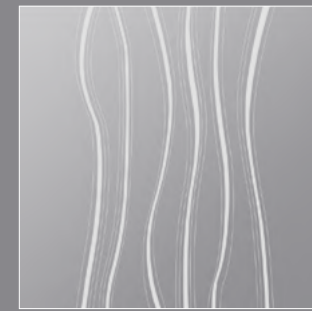

SAGI

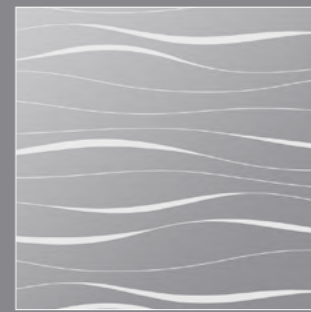

ONDA 1

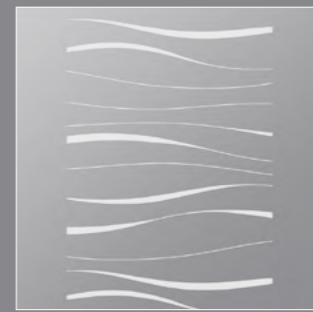

ONDA 2



MOTUS

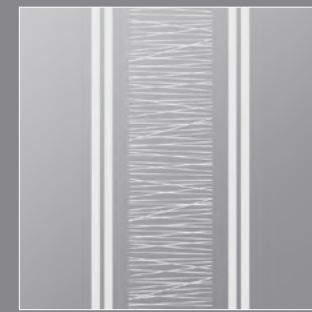

CENTRO



FLORA 1



FLORA 2



TOP

STYLE

PREMIUM

# Beschlagsvielfalt in Stil und System

## Diverse fitting styles and systems

### TÜRGRIFFE UND ZUBEHÖR FÜR ALLE ANWENDUNGEN

Türbeschläge sind ein prägendes Stilelement der Tür und unterstreichen die architektonische Note des Raums. Unser umfassendes Sortiment bietet eine Vielzahl an Designs und für jede Anforderung die passende Lösung: vom Türgriff, über das Glastürschloss bis hin zu passenden Bändern.

### DOOR HANDLES AND ACCESSORIES FOR ALL APPLICATIONS

Door handles are distinctive elements of the door. They make a style statement and underline the room's architectural tone. We offer a comprehensive range of designs and the perfect solutions for all requirements: from door handles to glass door locks and matching hinges.



TOP MONO











smart2lock  
by GRIFFWERK

GARANT

Griff  
werk

TOP

MONO

 <p><b>MONO BB</b> Schnellmontagetechnik   Graphitschwarz Quick mounting mechanism   Graphite black</p>	 <p><b>MONO BB</b> Schnellmontagetechnik   Edelstahl matt Quick mounting mechanism   Matte stainless steel</p>
 <p><b>smart2lock</b> by GRIFFWERK</p> <p><b>MONO</b> Schnellmontagetechnik   Graphitschwarz Quick mounting mechanism   Graphite black</p>	 <p><b>smart2lock</b> by GRIFFWERK</p> <p><b>MONO</b> Schnellmontagetechnik   Edelstahl matt Quick mounting mechanism   Matte stainless steel</p>
 <p><b>MONO GGT</b> Glastürbeschlag PURISTO S   Graphitschwarz Glass door fittings   Graphite black</p>	 <p><b>MONO GGT</b> Glastürbeschlag PURISTO S   Edelstahl matt Glass door fittings   Matte stainless steel</p>
 <p><b>smart2lock</b> by GRIFFWERK</p> <p><b>MONO GGT</b> Glastürbeschlag PURISTO S   Graphitschwarz Glass door fittings   Graphite black</p>	 <p><b>smart2lock</b> by GRIFFWERK</p> <p><b>MONO GGT</b> Glastürbeschlag PURISTO S   Edelstahl matt Glass door fittings   Matte stainless steel</p>

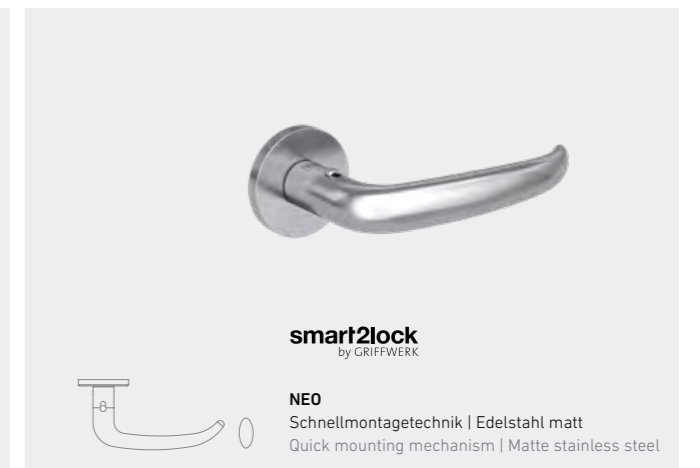
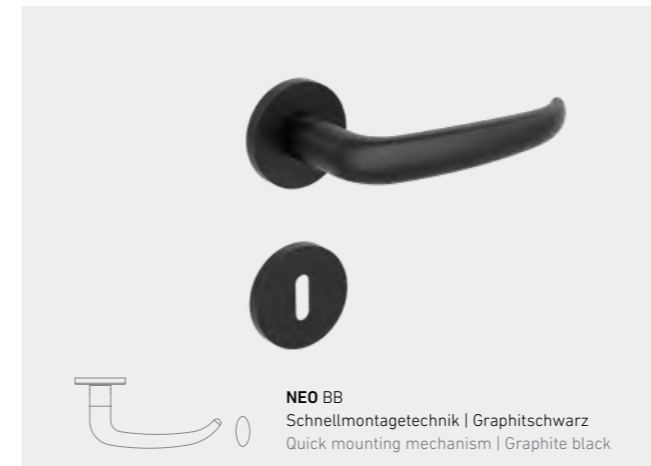
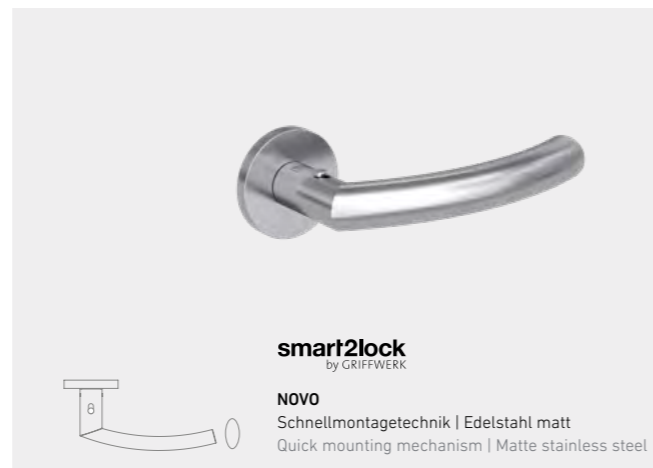
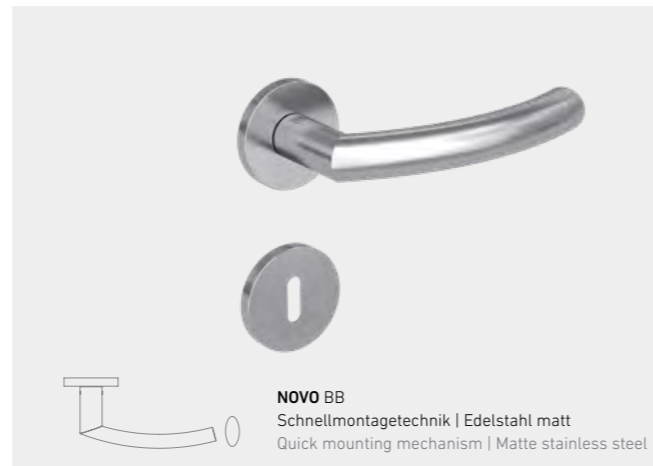
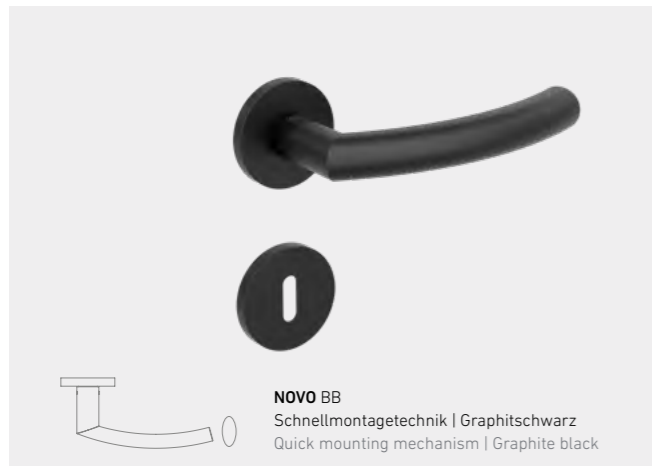



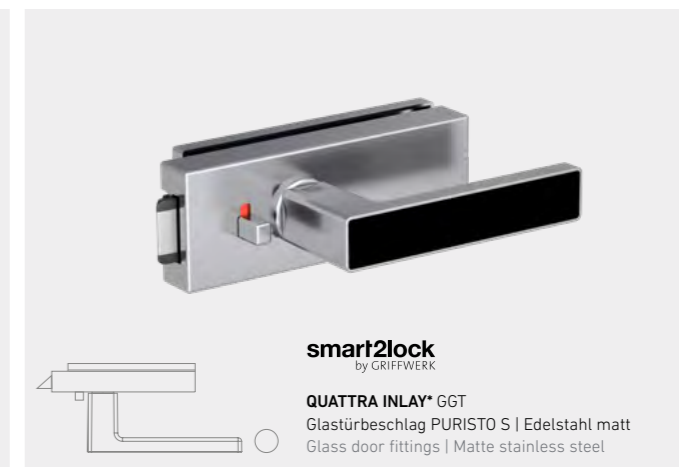
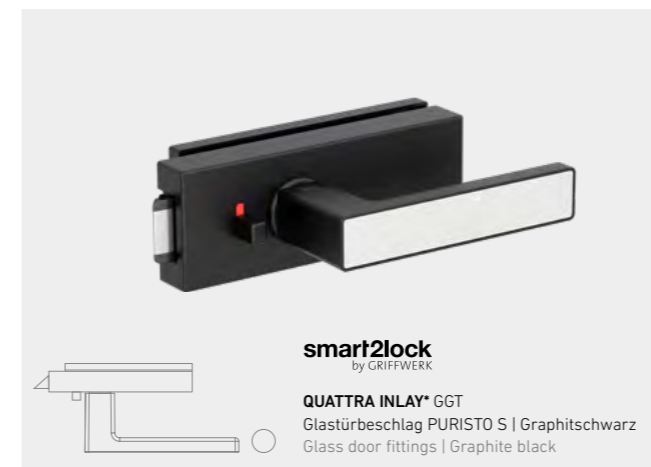
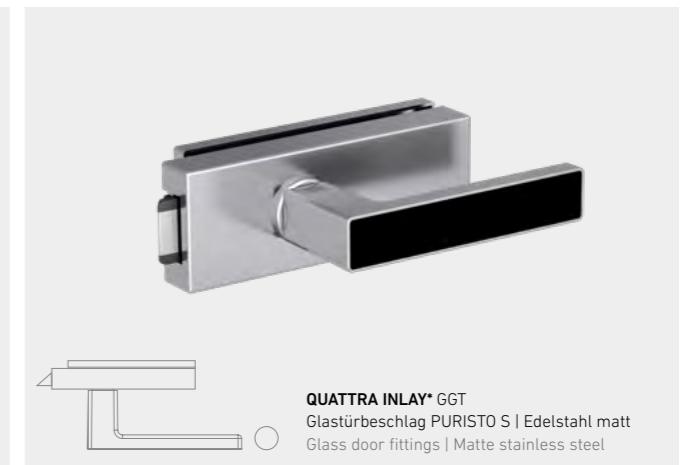
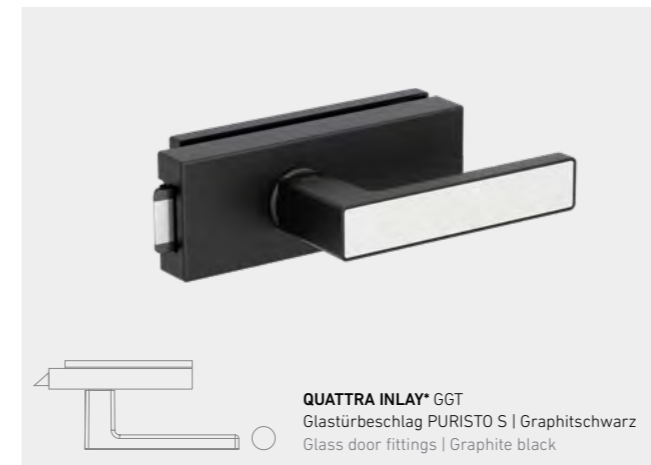
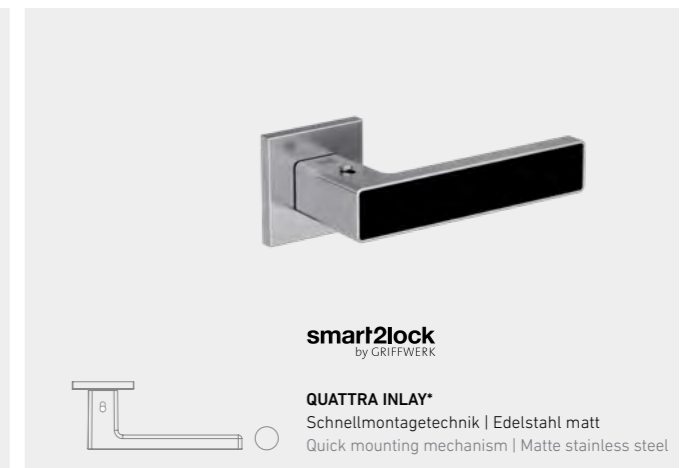
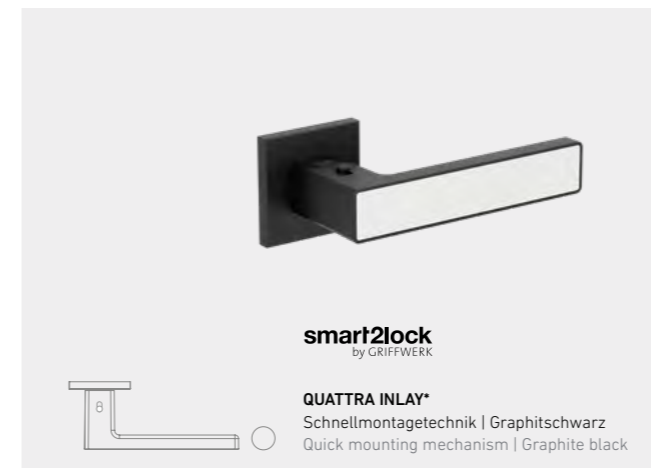
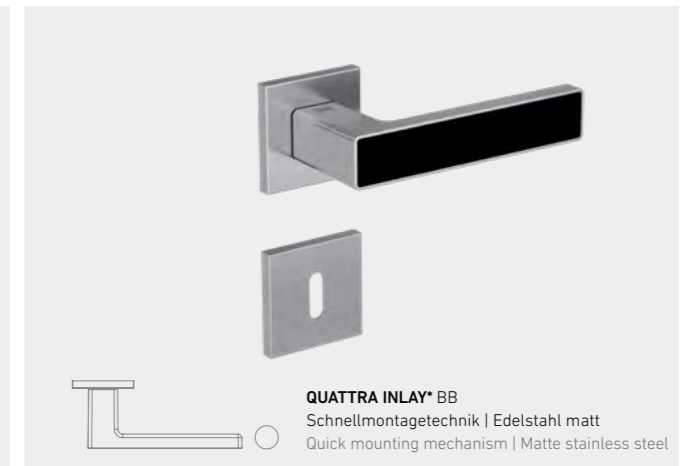
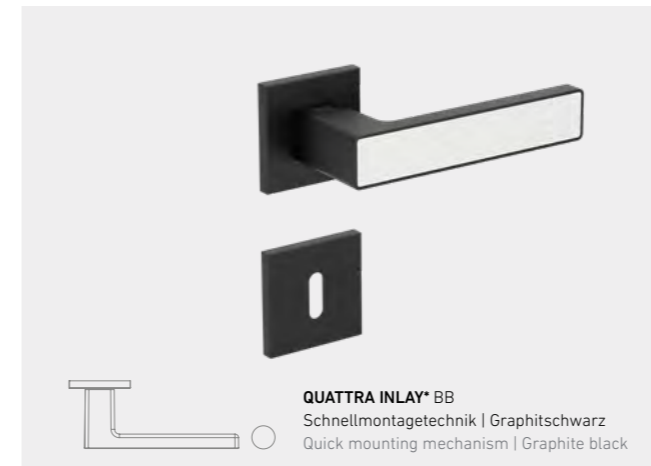
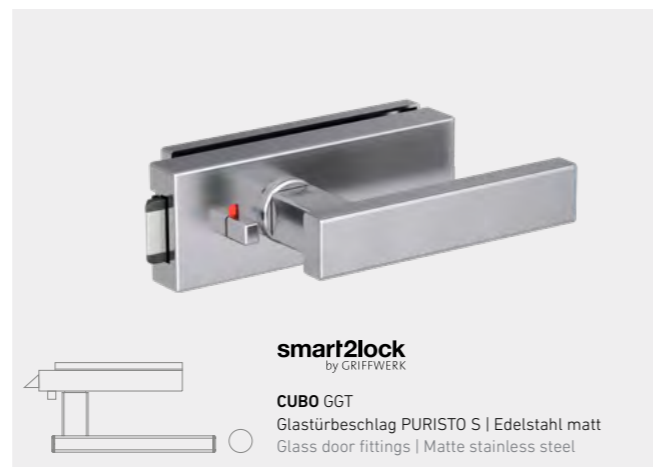
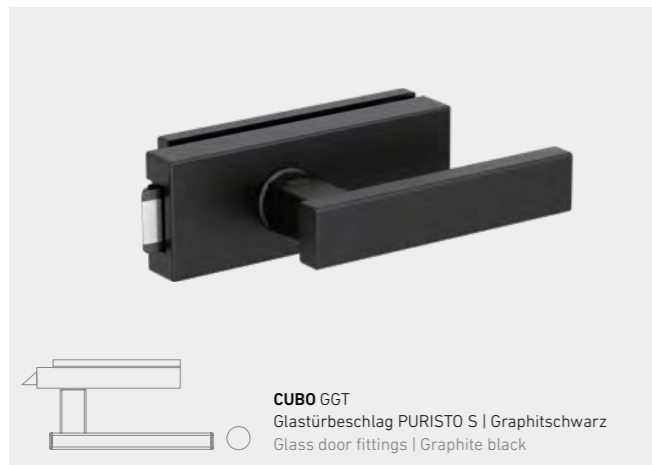
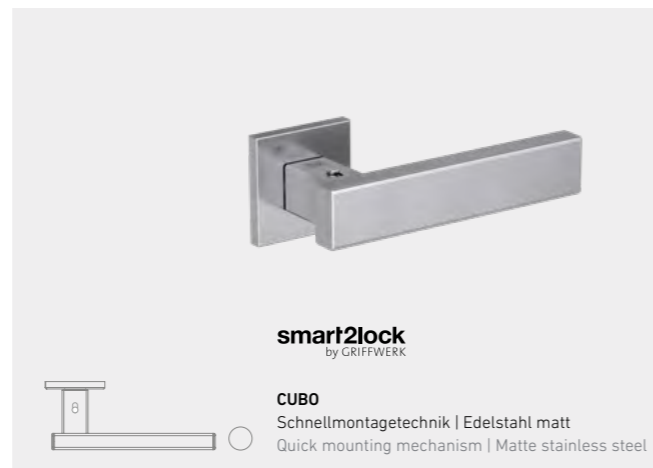
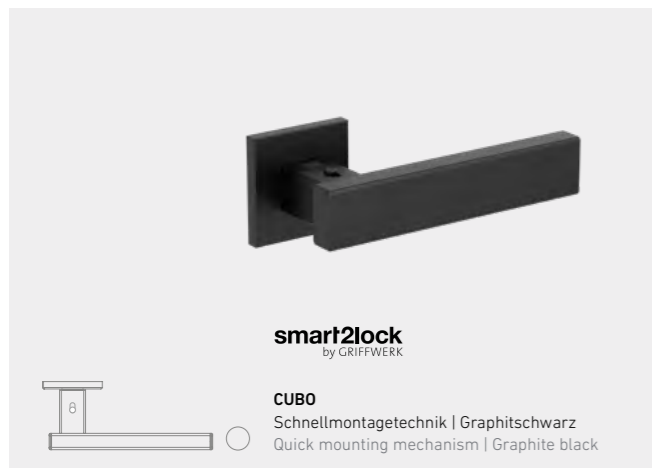

\*Inlays in allen G-TEC®-Oberflächen erhältlich \*Inlays available in all G-TEC® surfaces

MONO

STANDARD-ROSETTE  
STANDARD ROSETTE



BB-Schloss Rosette  
BB lock with magnetic rosette



WC-Schloss  
WC lock

PZ-Schloss  
PZ lock



Schutzbeschlag EH, RD  
EH, RD security lock plate

BÄNDER SCHLÖSSER  
HINGES LOCKS



2-teiliges Holztürenband  
2-part wooden door hinge



3-teiliges Holztürenband  
3-part wooden door hinge



BB/PZ Schloss  
Schlossstulp  
BB/PC lock  
lock neck



Magnetschloß lang  
Schlossstulp  
Long magnetic lock  
lock neck



Schließblech lang  
Long locking plate

MONO

STANDARD  
STANDARD



UV-Schloss  
UV lock



PZ-Schloss  
PZ lock



smart2lock  
by GRIFFWERK

NOVO

STANDARD  
STANDARD



UV-Schloss  
UV lock



PZ-Schloss  
PZ lock



smart2lock  
by GRIFFWERK

NEO

STANDARD  
STANDARD



UV-Schloss  
UV lock



PZ-Schloss  
PZ lock



smart2lock  
by GRIFFWERK

CUBO

STANDARD  
STANDARD



UV-Schloss  
UV lock



PZ-Schloss  
PZ lock



smart2lock  
by GRIFFWERK

QUATTRA INLAY

STANDARD-ROSETTE  
STANDARD ROSETTE



BB-Schloss Rosette  
BB lock with magnetic rosette



WC-Schloss  
WC lock

PZ-Schloss  
PZ lock



Schutzbeschlag EH, RD  
EH, RD security lock plate

BÄNDER ZUBEHÖR  
HINGES ACCESSORIES



Gegenkasten (2-flg.)  
Strike box (2-part)



Band (3-tlg.)  
Hinge (3-part)



Schließblech kurz  
Short locking plate



MONO

STANDARD-ROSETTE  
STANDARD ROSETTE



BB-Schloss Rosette  
BB lock with magnetic rosette

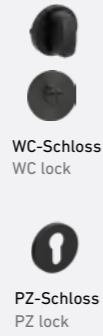

WC-Schloss  
WC lock  
PZ-Schloss  
PZ lock



Schutzbeschlag EH, RD  
EH, RD security lock plate

PZW-Knopf  
PZW knob

BÄNDER SCHLÖSSER  
HINGES LOCKS



2-teiliges Holztürenband  
2-part wooden door hinge



3-teiliges Holztürenband  
3-part wooden door hinge



BB/PC Schloss  
Schlossstulp Schwarz  
BB/PC lock  
Graphite black lock neck



Magnetschloß lang  
Schlossstulp Schwarz  
Long magnetic lock  
Graphite black lock neck



Schließblech lang  
Long locking plate

MONO

STANDARD  
STANDARD



UV-Schloss  
UV lock



PZ-Schloss  
PZ lock



smart2lock  
by GRIFFWERK

NOVO

STANDARD  
STANDARD



UV-Schloss  
UV lock



PZ-Schloss  
PZ lock



smart2lock  
by GRIFFWERK

NEO

STANDARD  
STANDARD



UV-Schloss  
UV lock



PZ-Schloss  
PZ lock



smart2lock  
by GRIFFWERK

CUBO

STANDARD  
STANDARD



UV-Schloss  
UV lock



PZ-Schloss  
PZ lock



smart2lock  
by GRIFFWERK

QUATTRA INLAY

STANDARD-ROSETTE  
STANDARD ROSETTE



BB-Schloss Rosette  
BB lock with magnetic rosette



WC-Schloss  
WC lock  
PZ-Schloss  
PZ lock



Schutzbeschlag EH, RD  
EH, RD security lock plate

PZW-Knopf  
PZW knob

BÄNDER ZUBEHÖR  
HINGES ACCESSORIES



Gegenkasten (2-flg.)  
Strike box (2-part)



Band (3-tlg.)  
Hinge (3-part)



Schließblech kurz  
Short locking plate

## Besondere Akzente setzen Make a big statement

### DESIGNTÜRGRIFFE, DIE IN STIL UND HAPTİK ÜBERZEUGEN

Außergewöhnliches Design und mehr Komfort: Die Tür erfährt durch unsere Designtürgriffe eine zusätzliche Aufwertung. Zudem bieten die hochwertigen Oberflächen eine angenehme Haptik – ein Luxus, den sie täglich erleben können.

### DESIGNER DOOR HANDLES WITH IMPRESSIVE STYLE AND HAPTICS

Exceptional design and extra convenience: Our designer door handles make the door look even more exclusive. Their premium finishes also enhance the haptics for luxury you can experience every day.



AVUS PIATTA S



**Griff  
werk**



**LUCIA PROFESSIONAL**  
Schraubtechnik | Graphitschwarz und Edelstahl matt  
Rund- oder Quadratrossette  
Screw mechanism | graphite black and matte stainless steel, round or square rosette



**LUCIA PIATTA S**  
Flachrossette | Graphitschwarz und Edelstahl matt  
Rund- oder Quadratrossette  
Flat rosette | graphite black and matte stainless steel, round or square rosette



**TRI 134**  
Schraubtechnik | Graphitschwarz und Edelstahl matt  
Rund- oder Quadratrossette  
Screw mechanism | graphite black and matte stainless steel, round or square rosette



**TRI 134 PIATTA S**  
Flachrossette | Graphitschwarz und Edelstahl matt  
Rundrossette  
Flat rosette | graphite black and matte stainless steel, round or square rosette

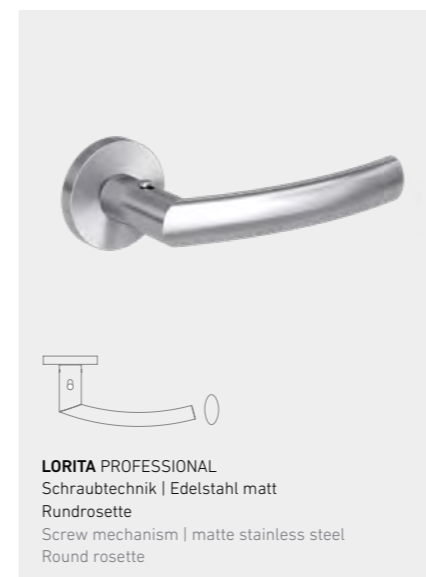

**LORITA PROFESSIONAL**  
Schraubtechnik | Edelstahl matt  
Rundrossette  
Screw mechanism | matte stainless steel  
Round rosette

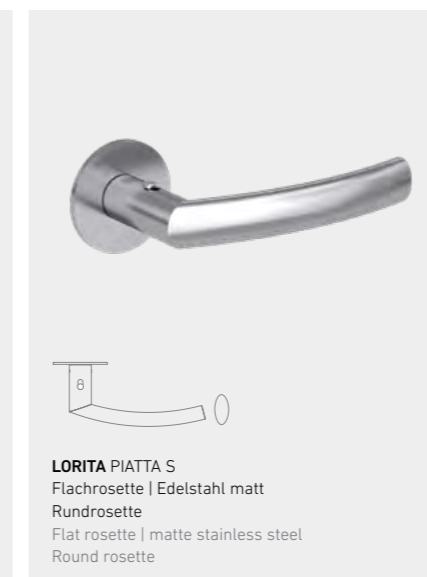

**LORITA PIATTA S**  
Flachrossette | Edelstahl matt  
Rundrossette  
Flat rosette | matte stainless steel  
Round rosette

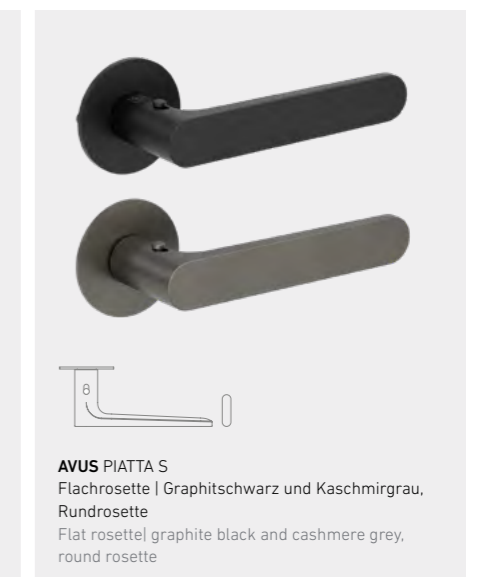

**AVUS PIATTA S**  
Flachrossette | Graphitschwarz und Kaschmirgrau,  
Rundrossette  
Flat rosette | graphite black and cashmere grey,  
round rosette



## Türgriffe der Extraklasse

### Extra-special door handles

#### ONE – DESIGNKONZEPT OHNE ROSETTEN

Maximale Reduktion, dafür steht ONE: Auf Rosetten wird bei dieser Türgriffserie völlig verzichtet. Der Griff sitzt direkt auf dem Türblatt auf und passt dennoch auf Türen mit Standardschlössern. Bei der Version mit Schließmechanik wurde diese in den Griffhals integriert. Ein Griffdesign für höchste Ansprüche.

#### ONE – NO-ROSETTE DESIGN

ONE is all about minimalism: this range of door handles dispenses entirely with rosettes. The handle is positioned directly on the door and it is suitable for doors with standard locks. In the version with locking mechanism, the locking mechanism is located in the handle neck. A handle designed to meet highest expectations.

AVUS ONE



Griff  
werk



#### AVUS ONE

Rosettenlos | Samtgrau, Graphitschwarz,  
Kaschmirgrau, Gold  
No rosette | velvet grey, graphite black,  
cashmere grey, gold

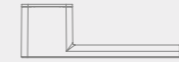

#### smart2lock by GRIFFWERK

#### AVUS ONE

Rosettenlos | Samtgrau, Graphitschwarz,  
Kaschmirgrau, Gold  
No rosette | velvet grey, graphite black,  
cashmere grey, gold

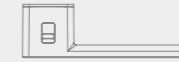

#### R8 ONE

Rosettenlos | Samtgrau, Graphitschwarz,  
Kaschmirgrau  
No rosette | matte stainless steel, graphite grey,  
cashmere grey



#### smart2lock by GRIFFWERK

#### R8 ONE

Rosettenlos | Samtgrau, Graphitschwarz,  
Kaschmirgrau  
No rosette | matte stainless steel, graphite grey,  
cashmere grey



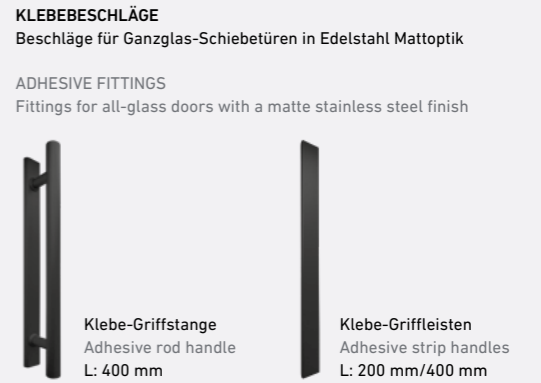
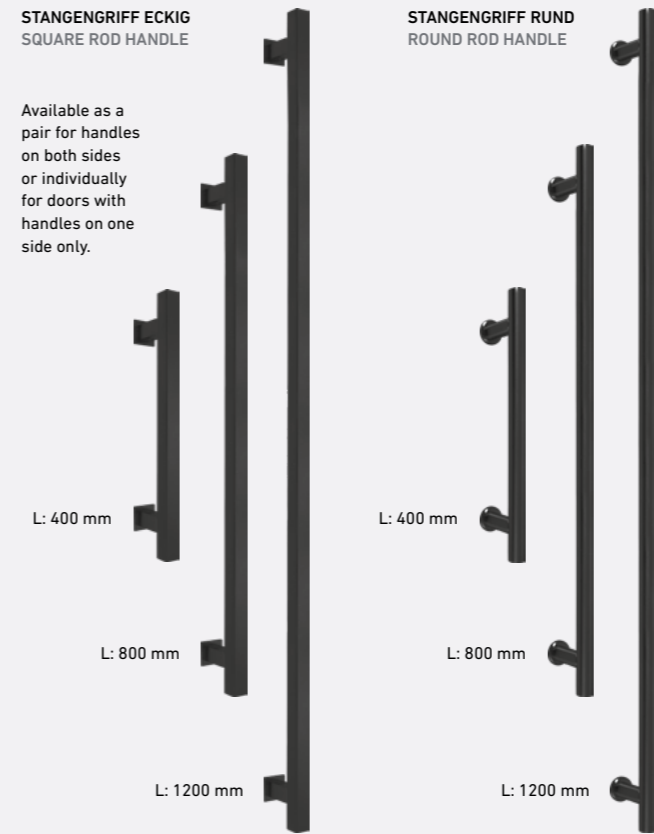
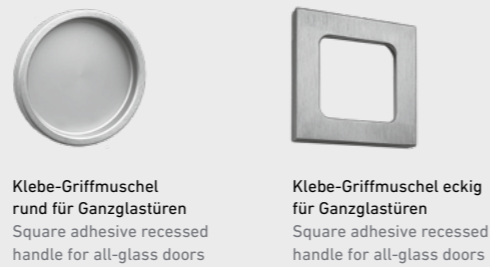
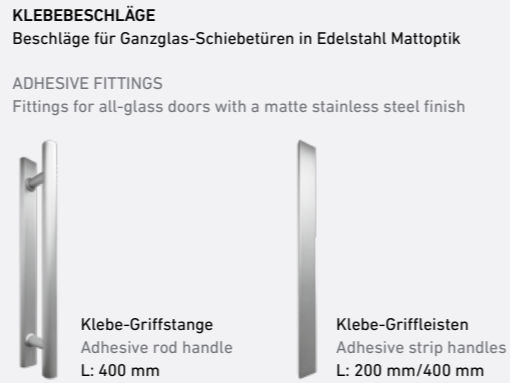
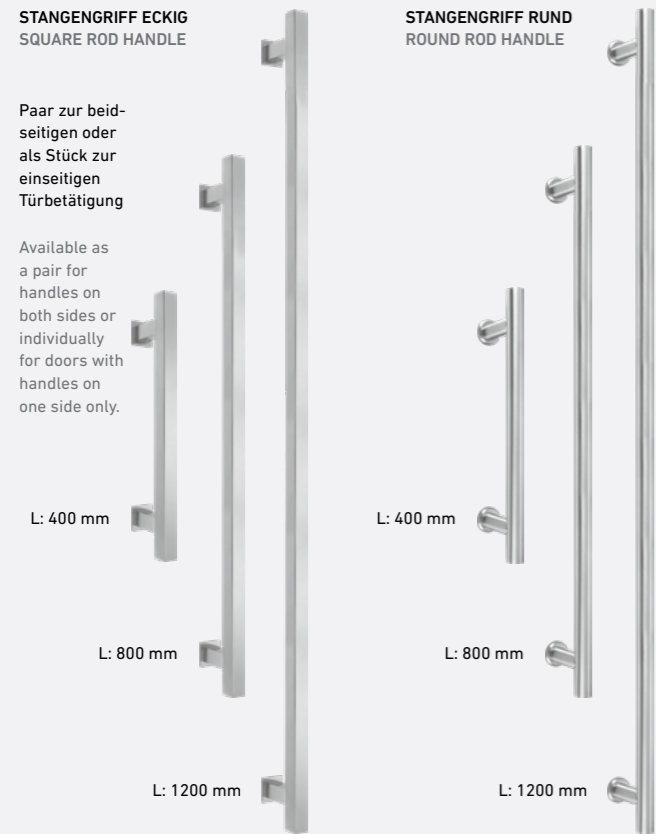

\*ähnlich RAL9005 \*like RAL9005

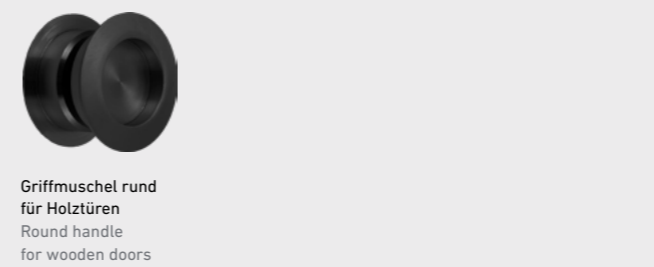



# Kantenausführungen an G-TEC®-Türblättern

Edge designs for G-TEC® doors

Drei Kantenausführungen bieten individuelle Auswahlmöglichkeiten für jede Anforderung. Die kleine Rundkante schmeichelt mit gefälliger Rundung, die eckige Kante steht für gradlinige Klassik und die Premiumkante besticht mit ihrer Nullfugen-Technologie. There is a choice of three edge designs to meet any requirement. The small rounded edge has a flattering radius, the square edge represents clean classic design and the premium edge boasts zero-joint technology.

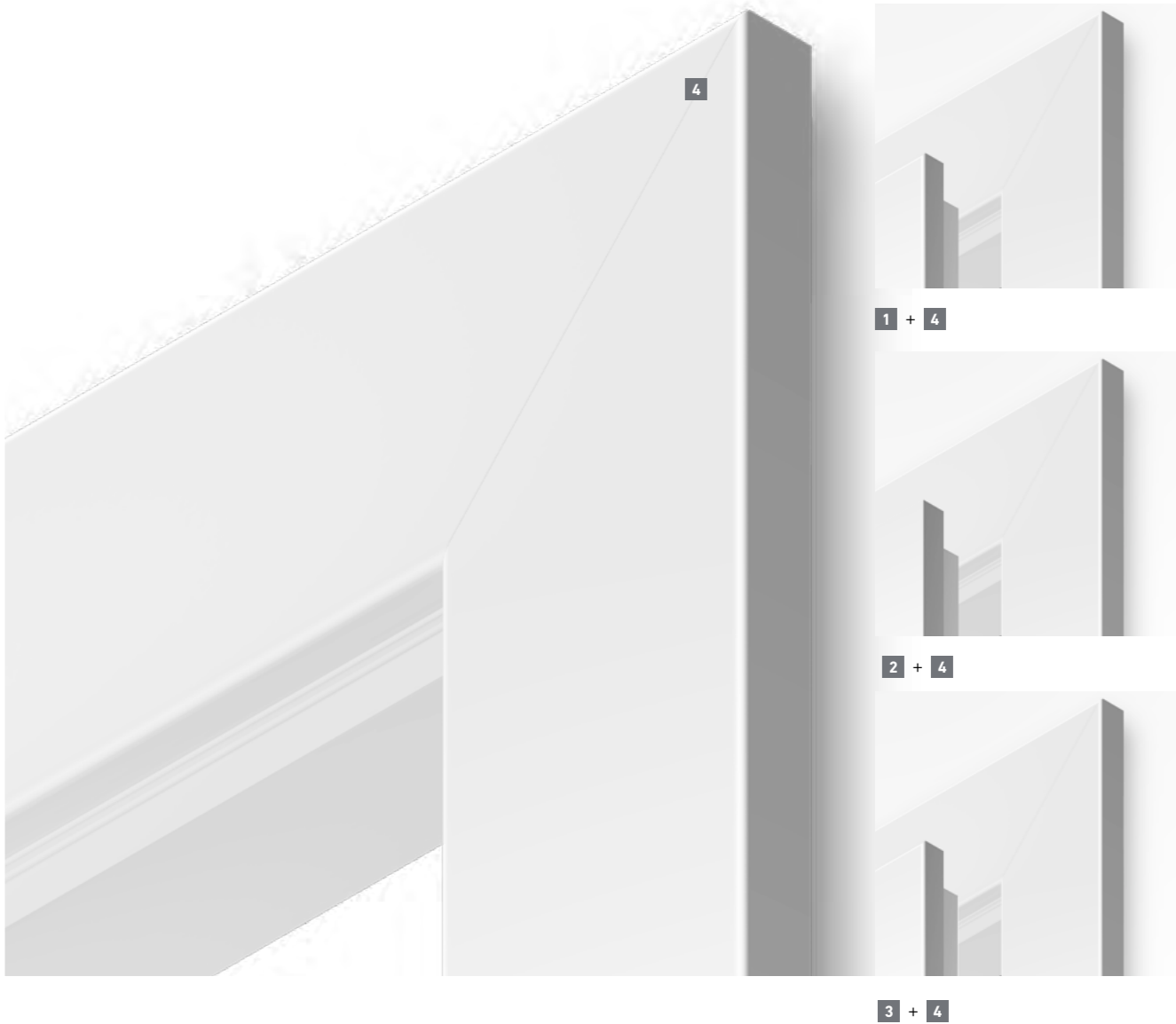
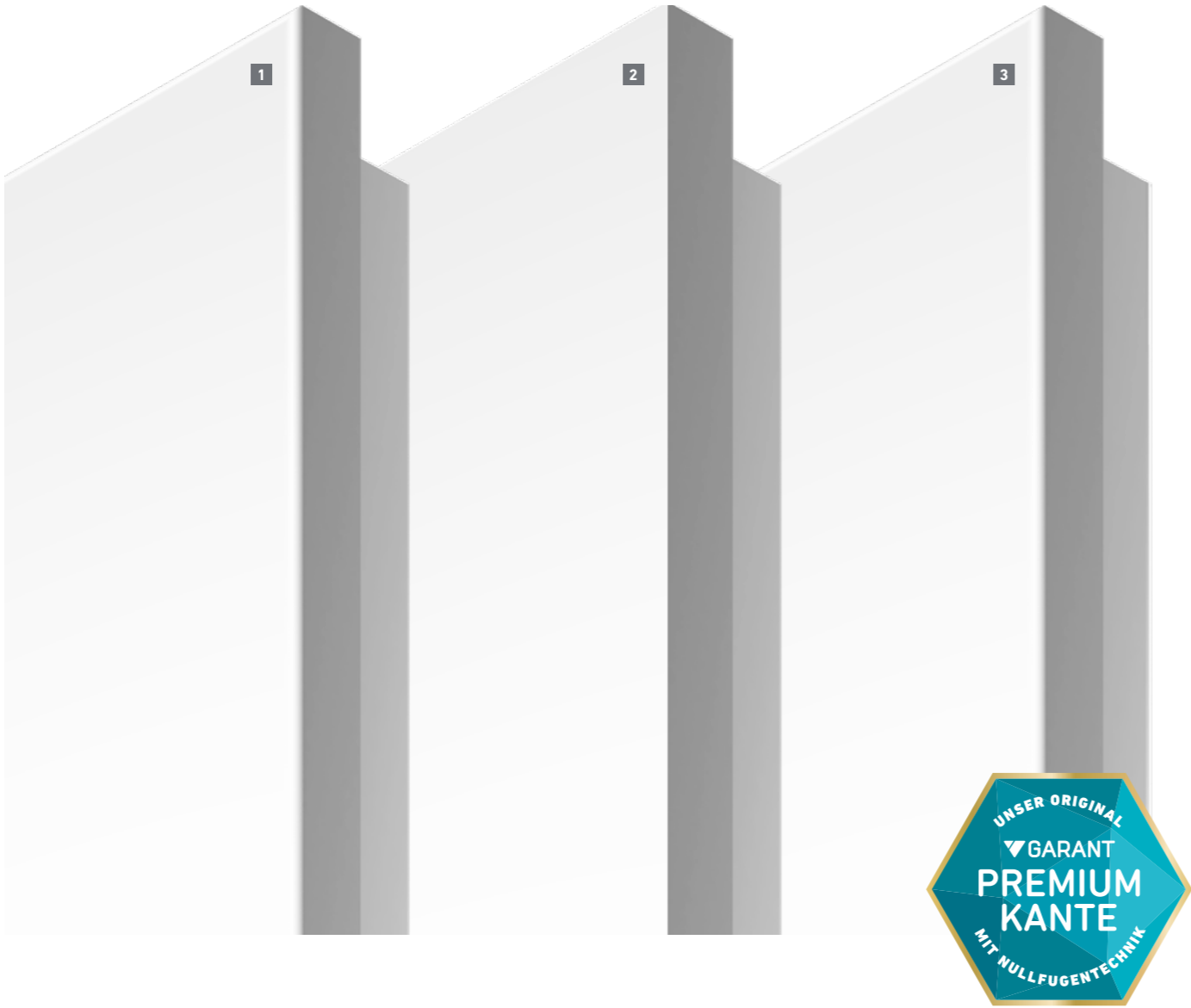

## TÜRBLATT-QUERSCHNITT | DOOR CROSS-SECTION

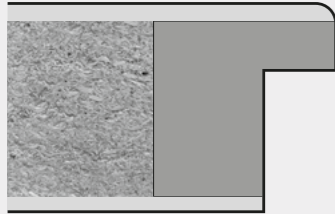

1 KLEINE RUNDKANTE (KR)  
SMALL ROUNDED EDGE (KR)

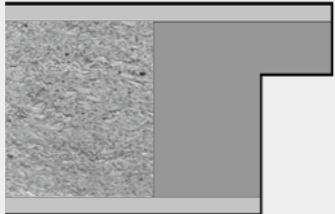

2 ECKIGE KANTE (EC)  
SQUARE EDGE (EC)

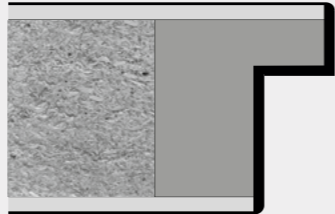

3 PREMIUMKANTE (PK2.0)  
PREMIUM EDGE (PK2.0)

## ZARGEN-QUERSCHNITT | FRAME CROSS-SECTION

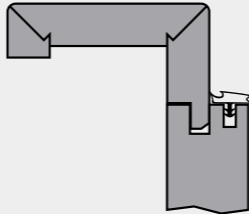

4 ZARGE MIT KLEINER RUNDKANTE  
FRAME WITH SMALL ROUNDED EDGE

## BÄNDER | HINGES

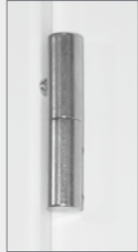

2-tlg. Band  
2-piece hinge



3-tlg. Band  
3-piece hinge

# G-TEC®-Eigenschaften

## G-TEC® properties

Hinterlässt keinen Abdruck, sondern Eindruck!  
Excellent anti-fingerprint properties!

Die attraktive Modellreihe G-TEC® weist eine qualitativ hochwertige Oberfläche auf, die eine hochmatte Farbgebung gewährleistet. Diese Elemente garantieren eine angenehme Haptik mit praktischer Anti-Fingerprint-Eigenschaft. Gerade bei der Wahl einer dunklen Farbe ist es entscheidend, dass selbst bei einer intensiven Nutzung keine Fingerabdrücke zu sehen sind.

Zudem bleibt dieser Effekt auch nach einer sanften Reinigung erhalten. Lichtecht und weniger kratzempfindlich steht diese Oberfläche für eine lange Nutzungsdauer und eine gewisse Belastbarkeit. Türen und Zargen mit G-TEC®-Oberflächen werden mit einer kleinen Rundkante ausgestattet.

The attractive G-TEC® models have a high-quality finish that makes an ultra-matte varnish possible. These elements guarantee a pleasant feel and have practical anti-fingerprint properties. When you choose a dark colour it is important that no fingerprints are visible, even when the door is in frequent use.

The anti-fingerprint effect remains intact even after gentle cleaning. Light-fast and scratch-resistant, this finish is designed for a long lifespan and good durability. Doors and frames with G-TEC® finishes have a small round edge.



Anti-Fingerprint –  
Keine Fingerabdrücke



Hochmatte  
Trend-Oberfläche



Weniger kratzempfindlich  
≥ 1,5 N nach Erichsen



Verbesserte  
Oberflächenruhe



# G-TEC® mit Funktion

## G-TEC® for functional doors

Alle Türen mit G-TEC®-Oberflächen können auch als Funktionstür ausgestattet werden. Hier steht die volle Bandbreite von Türen mit Barrierefreiheit über einbruchssichere Türen, Türen mit Schall- und Wärmeschutz bis zur Brandschutztür zur Auswahl.

All the doors with G-TEC® finishes can be functional doors. There are a wide range of options in this respect, from accessibility doors to anti-burglary doors, doors with heat and noise insulation and fire doors.



**BARRIEREFREIHEIT**  
ACCESSIBILITY



**KLIMASTABILITÄT**  
CLIMATE STABILITY



**MECHANISCHE BEANSPRUCHUNG**  
MECHANICAL STRESS



**SCHALLSCHUTZ**  
NOISE INSULATION



**EINBRUCHSCHUTZ**  
ANTI-BURGLARY



**FEUERSCHUTZ**  
FIRE PROTECTION



**RAUCHSCHUTZ**  
SMOKE PROTECTION



**WÄRMEDÄMMSCHUTZ**  
HEAT INSULATION



# G-TEC® mit Funktion

## G-TEC® functional doors

Unsere Funktionstüren schützen Sie und Ihre privaten oder geschäftlichen Räume und Güter vor den unterschiedlichsten negativen Einflüssen wie Schall, Einbruch, Feuer und Rauch.

Our functional doors protect you, your home and your business premises and assets from the diverse negative effects of noise, burglary, fire and smoke.





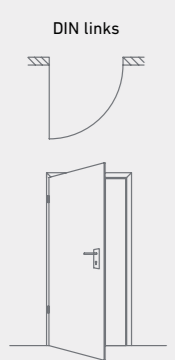
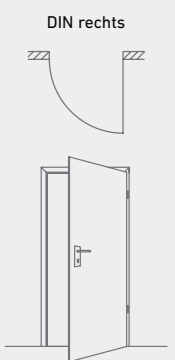

TÜRBLATTGRÖSSEN (VORZUGSGRÖSSEN NACH DIN 18101)											
EINFLÜGELIGE TÜREN						ZWEIFLÜGELIGE TÜREN					
Wandöffnungsmaß		Türblatt-Außenmaße				Wandöffnungsmaß		Türblatt-Außenmaße			
		Gefälztes Türblatt		Ungefälztes Türblatt				Gefälztes Türblatt		Ungefälztes Türblatt	
Breite (b1)	Höhe (h1)	Breite (b5)	Höhe (h5)	Breite (b5)	Höhe (h5)	Breite (b1)	Höhe (h1)	Breite (b5)	Höhe (h5)	Breite (b5)	Höhe (h5)
635	2005	610	1985	584	1972	1260	2005	1210	1985	1184	1972
760	2005	735	1985	709	1972	1510	2005	1460	1985	1434	1972
885	2005	860	1985	834	1972	1760	2005	1710	1985	1684	1972
1010	2005	985	1985	959	1972	2010	2005	1960	1985	1934	1972
1135	2005	1110	1985	1084	1972	2350	2005	2210	1985	2184	1972
1260	2005	1235	1985	1209	1972	2600	2005	2460	1985	2434	1972
635	2130	610	2110	584	2097	1260	2130	1210	2110	1184	2097
760	2130	735	2110	709	2097	1510	2130	1460	2110	1434	2097
885	2130	860	2110	834	2097	1760	2130	1710	2110	1684	2097
1010	2130	985	2110	959	2097	2010	2130	1960	2110	1934	2097
1135	2130	1110	2110	1084	2097	2350	2130	2210	2110	2184	2097
1260	2130	1235	2110	1209	2097	2600	2130	2460	2110	2434	2097

1. Normalhöhe nach DIN 18100 (Nennmaß) (h1)	2005						2130							
Maueröffnungshöhe min.-max. in [mm] (h1)	2000-2015*						2125-2140*							
Türblattaußenmaße in [mm] (h5)	1985						2110							
2. Normalbreite (1 flg.) nach DIN 18100 (Nennmaß) (b1)	635			885			1010			1260				
Maueröffnungsbreite min.-max. in [mm] (b1)	625-645*			875-895*			1000-1020*			1250-1270*				
Türblattaußenmaße in [mm] (b5)	610			860			985			1235				
3. Normalbreite (2 flg.) nach DIN 18100 (Nennmaß)	1260			1510			1760			2010				
Maueröffnungsbreite min.-max. in [mm]	1250-1270*			1500-1520*			1750-1770*			2000-2020*				
Türblattaußenmaße in [mm]	1210			1460			1710			1960				
* Bei Einsatz einer Holzumfassungszarge empfiehlt GARANT das Maximalmaß.														
4. Verstellbarkeit in [mm]	80-100	100-120	120-140	140-160	160-180	180-200	200-220	215-235	235-255	255-275	265-285	285-305	305-320	320-340
Futterbreite/Wanddicke	85	105	125	145	165	185	205	220	240	260	270	290	310	325

ZUBEHÖR

SCHLÖSSER

DICHTUNG



MODELL: BUNTBART-SCHLOSS



MODELL: PROFILZYLINDER-SCHLOSS



MODELL: SCHLOSS FÜR BADTÜREN



MODELL: ABSENKBARE BODENDICHTUNG

BÄNDER



MODELL: BANDKOMBINATION V 3420 WF FÜR HOLZZARGE



MODELL: BANDKOMBINATION V 4426 WF FÜR HOLZZARGE



MODELL: BANDKOMBINATION V 8026 WF FÜR STAHLZARGE

DOOR LEAF SIZES (STANDARD SIZES AS PER DIN 18101)											
SINGLE-LEAF DOORS						DOUBLE-LEAF DOORS					
Wall aperture measurements		Door leaf external measurements				Wall aperture measurements		Door leaf external measurements			
		Rebated door leaf		Flush door leaf				Rebated door leaf		Flush door leaf	
Length (b1)	Height (h1)	Length (b5)	Height (h5)	Length (b5)	Height (h5)	Length (b1)	Height (h1)	Length (b5)	Height (h5)	Length (b5)	Height (h5)
635	2005	610	1985	584	1972	1260	2005	1210	1985	1184	1972
760	2005	735	1985	709	1972	1510	2005	1460	1985	1434	1972
885	2005	860	1985	834	1972	1760	2005	1710	1985	1684	1972
1010	2005	985	1985	959	1972	2010	2005	1960	1985	1934	1972
1135	2005	1110	1985	1084	1972	2350	2005	2210	1985	2184	1972
1260	2005	1235	1985	1209	1972	2600	2005	2460	1985	2434	1972
635	2130	610	2110	584	2097	1260	2130	1210	2110	1184	2097
760	2130	735	2110	709	2097	1510	2130	1460	2110	1434	2097
885	2130	860	2110	834	2097	1760	2130	1710	2110	1684	2097
1010	2130	985	2110	959	2097	2010	2130	1960	2110	1934	2097
1135	2130	1110	2110	1084	2097	2350	2130	2210	2110	2184	2097
1260	2130	1235	2110	1209	2097	2600	2130	2460	2110	2434	2097

1. Standard height as per DIN 18100 (nominal height) (h1)	2005						2130							
Walleröffnungshöhe min.-max. in [mm] (h1)	2000-2015*						2125-2140*							
Door leaf external measurements [mm] (h5)	1985						2110							
2. Standard height (single leaf) as per DIN 18100 (nominal height) (b1)	635			885			1010			1260				
Walleröffnungsbreite min.-max. in [mm] (b1)	625-645*			875-895*			1000-1020*			1250-1270*				
Door leaf external measurements [mm] (b5)	610			860			985			1235				
3. Standard height (double leaf) as per DIN 18100 (nominal height) (b1)	1260			1510			1760			2010				
Walleröffnungsbreite min.-max. in [mm]	1250-1270*			1500-1520*			1750-1770*			2000-2020*				
Door leaf external measurements [mm]	1210			1460			1710			1960				
* GARANT recommends the maximum size if a closed wooden frame is being used.														
4. Adjustability in [mm]	80-100	100-120	120-140	140-160	160-180	180-200	200-220	215-235	235-255	255-275	265-285	285-305	305-320	320-340
Jamb width/ wall thickness	85	105	125	145	165	185	205	220	240	260	270	290	310	325

ACCESSORIES

LOCKS

SEALS



MODEL: WARDDED KEY LOCK



MODEL: PROFILE CYLINDER LOCK



MODEL: BATHROOM DOOR LOCK



MODEL: LOWERABLE BOTTOM SEAL

HINGES



MODEL: HINGE COMBINATION V 3420 WF FOR WOODEN FRAMES



MODEL: HINGE COMBINATION V 4426 WF FOR WOODEN FRAMES



MODEL: HINGE COMBINATION V 8026 WF FOR STEEL FRAMES

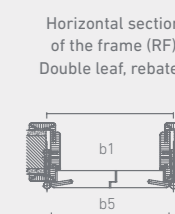
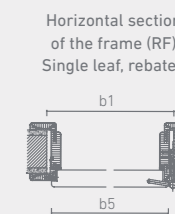
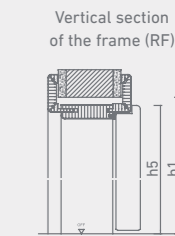
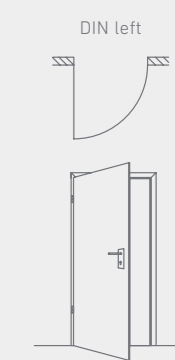
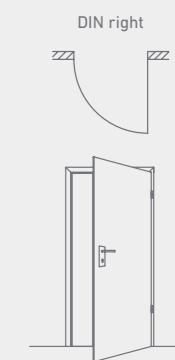



NORMTÜREN  
STANDARD DOORS

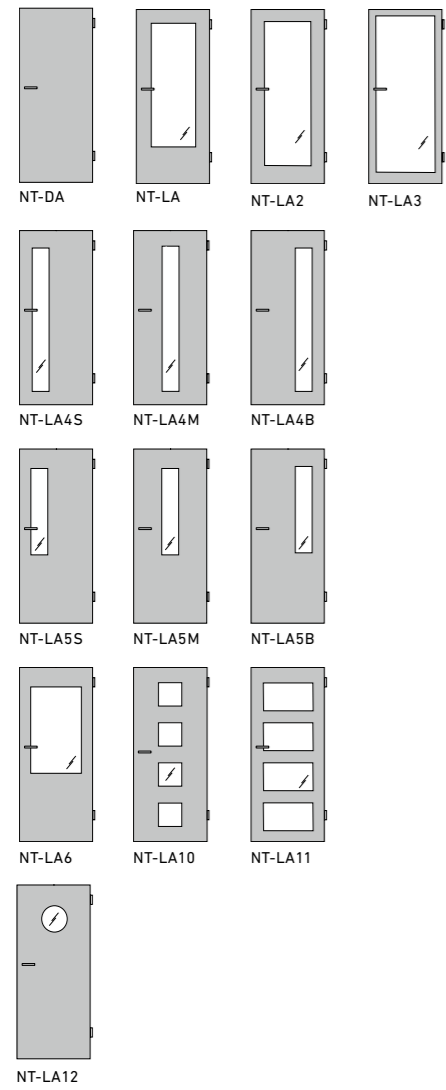

AURA  
AURA

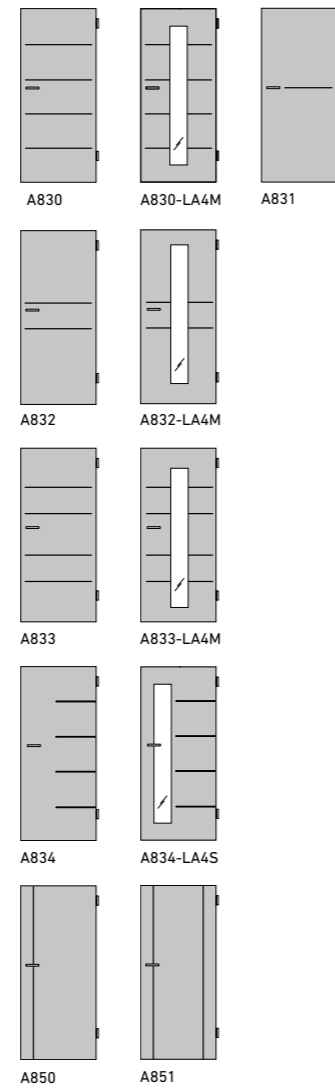

OBERFLÄCHEN | FINISHES

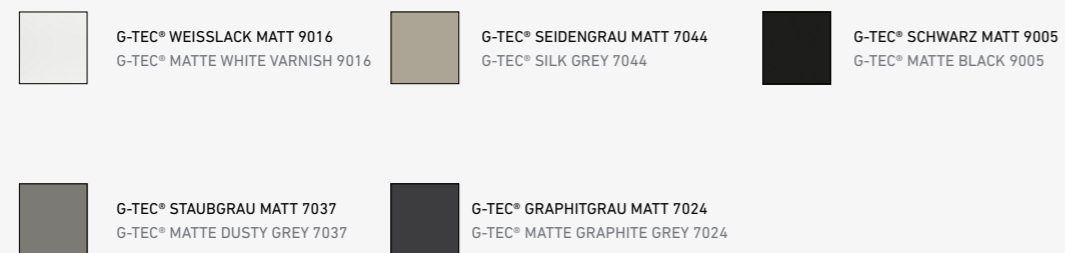

GANZGLASTÜREN DESIGN  
ALL-GLASS DESIGN DOORS

LASER-VEREDELUNG | LASER DÉCOR

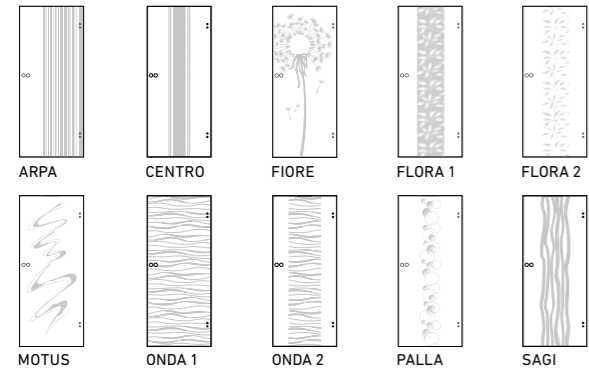

SIEBDRUCK-VEREDELUNG | SCREEN PRINTED DÉCOR

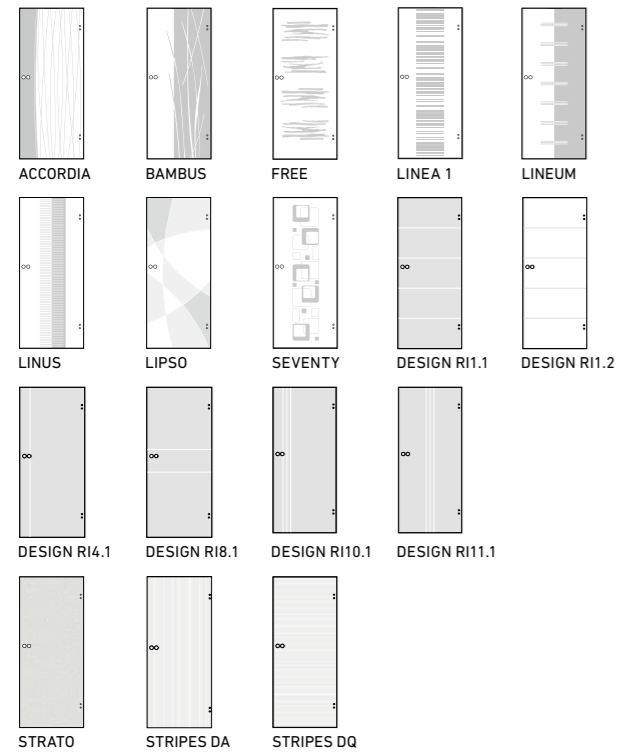

GANZGLASTÜREN ORNAMENT (NORM)  
PATTERNED ALL-GLASS DOORS (STANDARD)

STANDARD-ORNAMENTGLAS | STANDARD PATTERNED GLASS

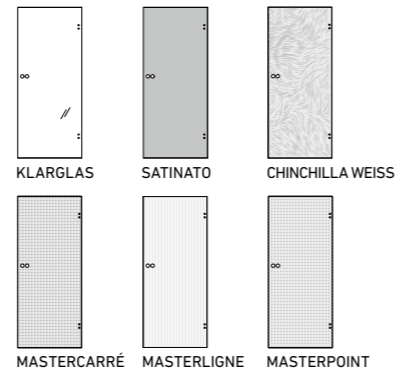

DESIGN-ORNAMENTGLAS | DESIGN PATTERNED GLASS

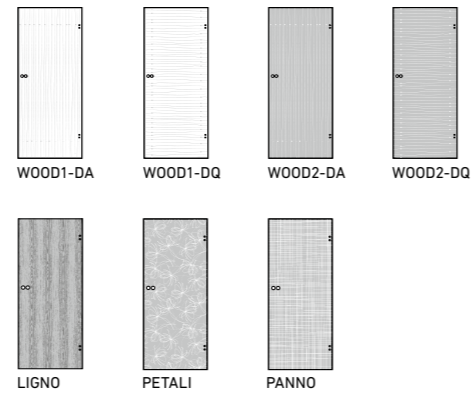

LICHTAUSSCHNITTGLÄSER  
GLASS PANELS

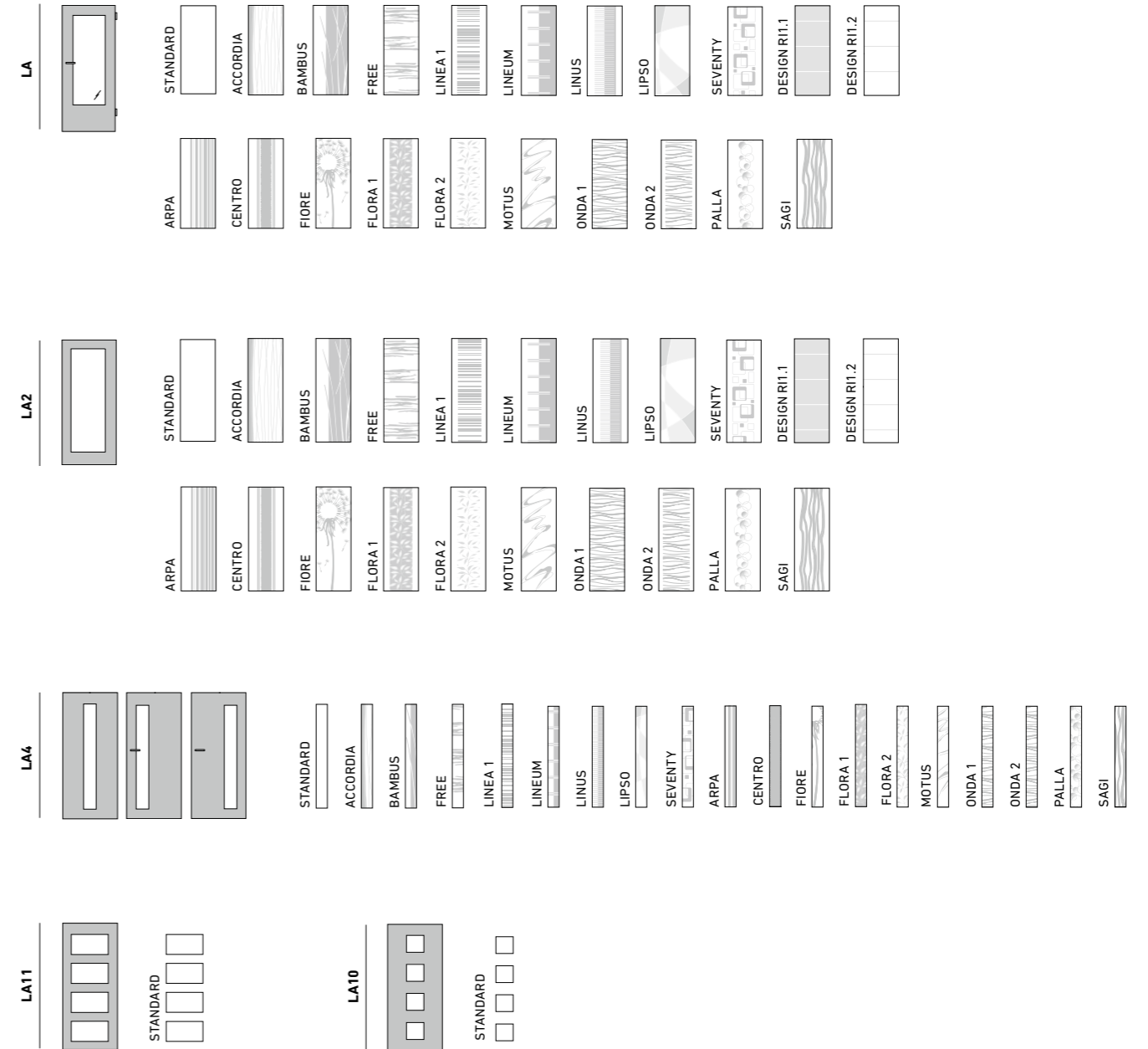

GLASBEISPIELE  
EXAMPLES OF GLASS

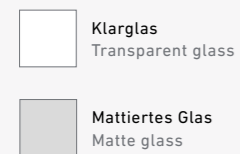

STANDARD-LICHTAUSSCHNITTGLÄSER ALS ORNAMENTGLAS  
STANDARD PATTERNED GLASS PANELS

- STANDARD-ORNAMENTGLÄSER**
- KLARGLAS
  - SATINATO
  - MASTERCARRÉ
  - MASTERLIGNE
  - MASTERPOINT
  - CHINCHILLA WEISS

- DESIGN-ORNAMENTGLÄSER**
- LIGNO
  - PETALI
  - PANNO
  - WOOD1-DA
  - WOOD1-DQ
  - WOOD2-DA
  - WOOD2-DQ

SPROSSENRAHMEN  
MUNTIN FRAMES

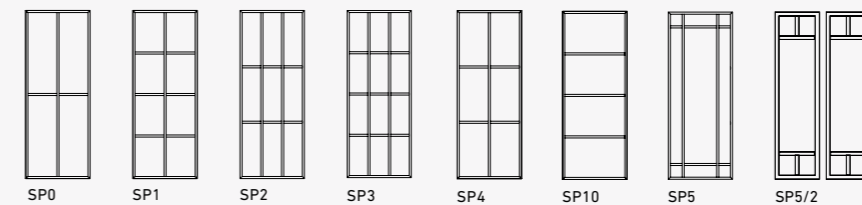



## GARANT Türen und Zargen GmbH

OT Icktershausen  
Garantstraße 1, Gewerbepark Thörey  
99334 Amt Wachsenburg

T +49 (0) 36202/91-0  
F +49 (0) 36202/91-150  
E [service@garant.de](mailto:service@garant.de)  
I [www.garant.de](http://www.garant.de)

Ein Unternehmen der Arbonia Doors

**ARBONIA**   
Doors

Ihr GARANT-Fachhändler:



 **GARANT**  
Türen für mein Zuhause

Stand 05/2023

Drucktechnisch bedingte Farbabweichungen  
sowie Änderungen am Produkt vorbehalten.

Gestaltung: Zentral-Marketing GARANT

Nur die mit FSC® gekennzeichneten Produkte sind zertifiziert.\*



MITGLIED DER



**GÜTE  
GEMEINSCHAFT  
INNENTÜREN**